

## Ordering Information

App. Code	Material ID	Length	Description
<b>Duplex Patch Cords</b>			
<b>White to White (Standard cord that patches equip. on rear of one jack block to equip. on rear of another)</b>			
800AD/3	105757835	3 ft / .9 m	White 800 male duplex plug to white 800 male duplex plug
800AD/6	105757843	6 ft / 1.8 m	White 800 male duplex plug to white 800 male duplex plug
800AD/12	105757850	12 ft / 3.6 m	White 800 male duplex plug to white 800 male duplex plug
800AD/25	105757868	25 ft / 7.6 m	White 800 male duplex plug to white 800 male duplex plug
800AD/50	105757876	50 ft / 15.2 m	White 800 male duplex plug to white 800 male duplex plug
<b>Blue to Blue (Special cord that patches equip. on front of one jack block to equip. on front of another)</b>			
800PD-PD/6	106985070	6 ft / 1.8 m	Blue 800 male duplex plug to blue 800 male duplex plug
800PD-PD/12	106985088	12 ft / 3.6 m	Blue 800 male duplex plug to blue 800 male duplex plug
800PD-PD/25	107079469	25 ft / 7.6 m	Blue 800 male duplex plug to blue 800 male duplex plug
800PD-PD/50	107079477	50 ft / 15.2 m	Blue 800 male duplex plug to blue 800 male duplex plug
<b>White to Blue (Special cord that patches equip. on rear of one jack block to equip. on front of another)</b>			
800AD-PD/6	106985096	6 ft / 1.8 m	White 800 male duplex plug to blue 800 male duplex plug
800AD-PD/12	106985104	12 ft / 3.6 m	White 800 male duplex plug to blue 800 male duplex plug
800AD-PD/25	107079485	25 ft / 7.6 m	White 800 male duplex plug to blue 800 male duplex plug
<b>Adapter Duplex Patch Cords</b>			
<b>(Patching between 800-type duplex jack and 310-type duplex jack)</b>			
800GD/3	105773964	3 ft / .9 m	White 800 male duplex plug to 310 male duplex plug
800GD/6	105773972	6 ft / 1.8 m	White 800 male duplex plug to 310 male duplex plug
800GD/12	105773980	12 ft / 3.6 m	White 800 male duplex plug to 310 male duplex plug
800GD/25	105773998	25 ft / 7.6 m	White 800 male duplex plug to 310 male duplex plug
800GD/50	105774004	50 ft / 15.2 m	White 800 male duplex plug to 310 male duplex plug
<b>(Patching between 800-type duplex jack and bantam-type duplex jack)</b>			
800HD/3	105774012	3 ft / .9 m	White 800 male duplex plug to bantam male duplex plug
800HD/6	105774020	6 ft / 1.8 m	White 800 male duplex plug to bantam male duplex plug
800HD/12	105774038	12 ft / 3.6 m	White 800 male duplex plug to bantam male duplex plug
800HD/25	105774046	25 ft / 7.6 m	White 800 male duplex plug to bantam male duplex plug
800HD/50	105774053	50 ft / 15.2 m	White 800 male duplex plug to bantam male duplex plug
<b>Duplex Test Cords</b>			
<b>Duplex White Test Cords (Access equip. terminated on rear of jack block)</b>			
800GY/12	106008568	12 ft / 3.6 m	"Y" cord w/ white 800 male duplex plug to two 310 male simplex plugs
800HY/12	106008576	12 ft / 3.6 m	"Y" cord w/ white 800 male duplex plug to two bantam male simplex plugs
<b>Duplex Blue Test Cords (Access equip. terminated on front of jack block)</b>			
800PGY/12	106463235	12 ft / 3.6 m	"Y" cord w/ blue 800 male duplex plug to two 310 male simplex plugs
800PHY/12	106463250	12 ft / 3.6 m	"Y" cord w/ blue 800 male duplex plug to two bantam male simplex plugs

## Ordering Information

App. Code	Material ID	Length	Description
<b>Duplex Orange Monitor/ Test Cords—Hitless (Monitors equip. terminated on rear and front of jack block)</b>			
800RGY/12	106412927	12 ft / 3.6 m	"Y" cord w/ orange 800 male duplex plug to two 310 male simplex plugs
800RHY/12	106412943	12 ft / 3.6 m	"Y" cord w/ orange 800 male duplex plug to two bantam male simplex plugs
800RHYBP/12	108043811	12 ft / 3.6 m	"Y" cord w/ orange 800 male duplex plug to two banana male simplex plugs
<b>Simplex Patch Cords</b>			
<b>Gray to Gray (Standard patch cord that patches equip. on rear of one jack block to equip. on rear of another)</b>			
800A/1	104198395	1 ft / .3 m	Gray 800 male simplex plug to gray 800 male simplex plug
800A/12	104194725	12 ft / 3.6 m	Gray 800 male simplex plug to gray 800 male simplex plug
800A/25	104409818	25 ft / 7.6 m	Gray 800 male simplex plug to gray 800 male simplex plug
<b>Adapter Simplex Patch Cords and Plugs</b>			
800C/0	104380407	N/A	Gray adapter plug - 800 female simplex jack to 310 male simplex plug
800E/1	104366885	1 ft / .3 m	Gray adapter cord - 800 male simplex plug to 310 female simplex jack
800F/1	104366893	1 ft / .3 m	Gray adapter cord - 800 male simplex plug to bantam female simplex jack
<b>Simplex Patch / Test Cords</b>			
800G/12	104366901	12 ft / 3.6 m	Gray 800 male simplex plug to 310 male simplex plug
800H/12	104366927	12 ft / 3.6 m	Gray 800 male simplex plug to bantam male simplex plug
<b>Simplex Drop and Insert Test Cord</b>			
800HDI/9	107237745	9 ft / 2.7 m	"Y" cord w/ 800 male simplex plug to two bantam male simplex plugs
<b>Wire-Wrap Pin Single Monitor Test Cord</b>			
<b>(Special cord for monitoring a signal via tip &amp; ring wire-wrap terminals of OUT or IN termination on DIXI-1 or 800 block)</b>			
DSAB1MC01-06L	106858491	6 ft / 1.8 m	Push-on wire-wrap pin plug (w/ resistors) to a bantam male simplex plug
DSAB1MC01-12L	106858475	12 ft / 3.6 m	Push-on wire-wrap pin plug (w/ resistors) to a bantam male simplex plug
<b>Regenerator Cords</b>			
<b>(Hand-held device which takes a -20 dB monitor jack signal and outputs a regenerated standard DSX-1 level signal)</b>			
<b>800 to 800 Regenerator Cords</b>			
DS1RGN-A1-800/4-800/60	107050361	64 ft / 19.4 m	800 male simplex plug input cord (4 ft/1.2 m) to 800 male simplex plug output cord (60 ft/18.2 m)
<b>800 to Bantam Regenerator Cords</b>			
DS1RGN-A1-800/4-BNP/60	107050353	64 ft / 19.4 m	800 male simplex plug input cord (4 ft/1.2 m) to bantam male simplex plug output cord (60 ft/18.2 m)
<b>Bantam to 800 Regenerator Cords</b>			
DS1RGN-A1-BNP/4-800/60	107050346	64 ft / 19.4 m	Bantam male simplex plug input cord (4 ft/1.2 m) to 800 male simplex plug output cord (60 ft/18.2 m)
<b>Miscellaneous Accessory Plugs</b>			
800B/0	104198411		Terminating plug with 100-ohm resistor between tip and ring
800B120/0	107286742		Terminating plug with 120-ohm resistor between tip and ring
800J/0	104387113		Dummy plug - plastic
800J2/0	106781487		Dummy "Jumper Out" plug (gold fingered)
800K2/0	105757926		Single loopback plug (loops OUT to IN of equip. terminated on rear of block)
800K3/0	106744543		Double loopback plug (loops back equip. terminated on rear and front of block)
800L/0	104412523		Flasher Jumper tracing tool (flashes tracing lamp LEDs at both ends of cross-connect)
800N/0	105514285		"Thru" plug (for cleaning 800-type jacks/non-service interrupting)

Material ID 847 633 336  
Issue 4, February 2004



## 800-Series, 900-Series DSX-1 DIXI-1 and DSAB-1 Patch and Test Cords and Accessory Plugs

Application  
and  
Ordering Guide

### How to Contact Us

- To find out more about Carrier Apparatus Products, visit us on the web at: <http://cw.commscope.com/>
- For technical assistance regarding Carrier Apparatus products: contact your local CommScope account representative or CommScope technical support at 1-800-344-0223.
- Report any missing or damaged parts to CommScope customer service in Omaha, Nebraska, at 1-866-539-2795.

— WHITE TO WHITE PATCH CORD (800AD TYPE)—

- Patches network element at rear of one DIXI-1/DSX-1 to network element at rear of another
- Disconnects signal from network element at front of DIXI-1/DSX-1.

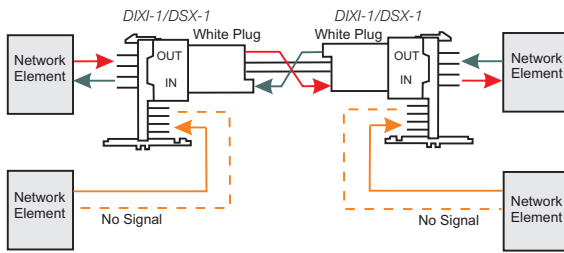

— LOOPBACK PLUG (800K2/K3 TYPE)—

- 800 K2/0 white plug loops network element at rear of DIXI-1/DSX-1
- 800 K3/0 yellow plug loops network elements at both rear and front of DIXI-1/DSX-1.

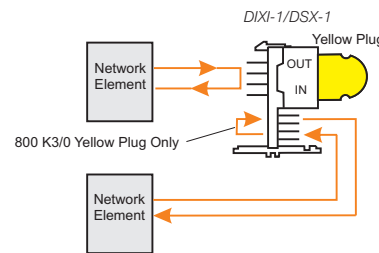

— ORANGE MONITOR CORD (800RGY/RHY TYPE)—

- Monitors signal from network element at rear and front of DIXI-1/DSX-1.

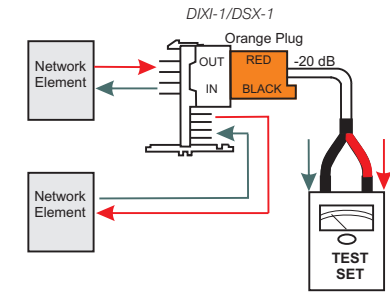

— BLUE TO BLUE PATCH CORD (800PD-PD TYPE)—

- Patches network element at front of one DIXI-1/DSX-1 to network element at front of another.
- Loops both network elements at rear of DIXI-1/DSX-1

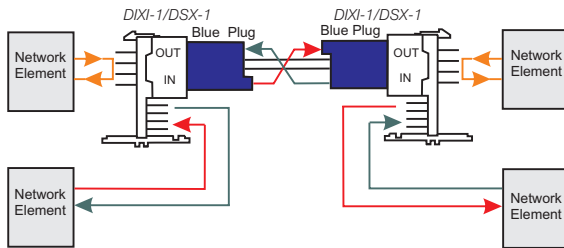

— WIRE-WRAP MONITOR CORD (DSAB TYPE)—

- Monitors signal from network element at front (IN or OUT) of DIXI-1/DSX-1/DSAB-1.

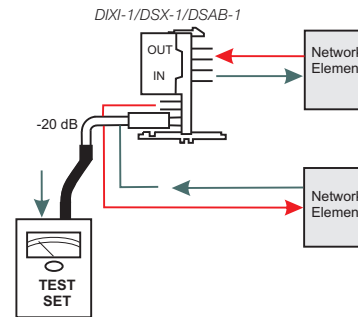

— WHITE TEST CORD (800GY/HY TYPE)—

- Tests signal from network element at rear of DIXI-1/DSX-1.
- Disconnects signal from network element at front of DIXI-1/DSX-1.

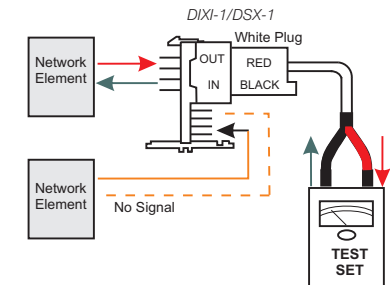

— WHITE TO BLUE PATCH CORD (800AD-PD TYPE)—

- Patches network element at rear of one DIXI-1/DSX-1 to network element at front of another.
- White plug loops network element at front of DIXI-1/DSX-1
- Blue plug loops network element at rear of DIXI-1/DSX-1

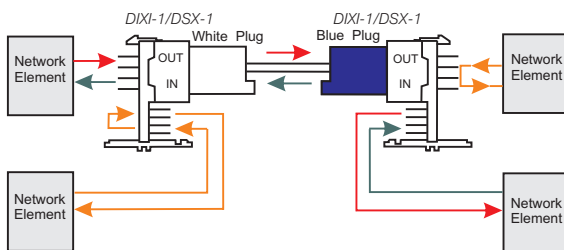

— DROP AND INSERT TEST CORD (800HD1 TYPE)—

- When plugged into OUT jack of DIXI-1/DSX-1, diverts signal coming into rear pins onto red lead to a test set where bit stream can be modified and altered signal returned on black lead to network element connected to front pins.
- When plugged into IN jack, diverts signal coming into front pins onto black lead to a test set and returns it on red lead to network element connected to back pins.

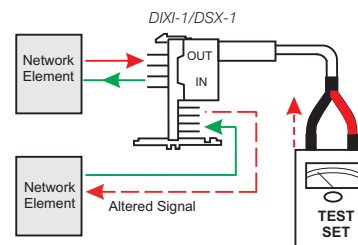

— BLUE TEST CORD (800PGY/PHY TYPE)—

- Test signal from network element at front of DIXI-1/DSX-1
- Disconnects signal from network element at rear of DIXI-1/DSX-1.

