

UNITED STATES DEPARTMENT OF AGRICULTURE
Rural Utilities Service

BULLETIN 1753F-401(PC-2)

SUBJECT: RUS Standard for Splicing Copper and Fiber Optic Cables

TO: All Telephone Borrowers
RUS Telephone Staff

EFFECTIVE DATE: February 27, 1995

EXPIRATION DATE: Date of change in 7 CFR 1755.200 by rulemaking.

OFFICE OF PRIMARY INTEREST: Outside Plant Branch,
Telecommunications Standards Division

PREVIOUS FILING INSTRUCTIONS: This bulletin replaces RUS
Bulletin 345-6, REA Standard for Splicing Plastic-Insulated
Cables, PC-2, issued January 12, 1978.

FILING INSTRUCTIONS: Discard RUS Bulletin 345-6, REA Standard
for Splicing Plastic Insulated Cables, PC-2, dated January 12,
1978, and replace with this bulletin. File with 7 CFR 1755 and
on RUSNET.

PURPOSE: This standard describes approved methods for splicing
plastic-insulated copper and fiber optic cables. This bulletin
is a user friendly guide and a reformat of the text in 7 CFR
1755.200 published at 60 FR 5096, dated January 26, 1995.

Every effort has been made to ensure the accuracy of this
document. However, in case of discrepancies, the regulations at
7 CFR 1755.200 are the authorized sources.

Wally Beyer

3/3/95

Administrator

Date

TABLE OF CONTENTS

CFR to Bulletin Conversion Table 4
Abbreviations 6
1. Scope 7
2. General 7
3. Splicing Considerations for Copper Cables 8
4. Splice Arrangement for Copper Cables 13
5. Splicing Considerations for Fiber Optic Cables 16
6. Splice Arrangements for Fiber Optic Cables 21
7. Bonding and Grounding Fiber Optic Cable, Copper Cable,
and Copper Service Wire 22

TABLES AND FIGURES

TABLE 1 Cable Pair Identification Within Binder Groups 9
TABLE 2 Cable Binder Group Identification 10
TABLE 3 Super-Unit Binder Colors 10
TABLE 4 Screened Cable Service Pair Identification 11
TABLE 5 Splice Capacities For BD-Type Pedestals 14
TABLE 6 Splice Capacities For Large Count Housings 15
TABLE 7 Fiber and Buffer Tube Identification 19
TABLE 8 Shield Bond Connectors Per Pair Size and Gauge 23

FIGURE 1 PEDESTAL RESTRICTED ACCESS INSERT 26
FIGURE 2 SERVICE WIRE CONNECTION TO BURIED CABLE 27
FIGURE 3 TYPICAL SPLICE USING SINGLE PAIR CONNECTIONS 28
FIGURE 4 LARGE SPLICE USING MULTIPLE PAIR CONNECTORS 29
FIGURE 5 LARGE SPLICE USING MULTIPLE PAIR CONNECTORS
MOUNTED ON ORGANIZER RACKS 30
FIGURE 6 CORE MISALIGNMENT 31
FIGURE 7 SPLICE LOSS CAUSED BY FIBER MANUFACTURER 32
FIGURE 8 IMPROPER CLEAVES VERSUS PROPER CLEAVE 33
FIGURE 9 AERIAL SPLICE STORED INSIDE PEDESTAL 34
FIGURE 10 BURIED SPLICE STORED INSIDE HANDHOLE 35
FIGURE 11 BURIED SPLICE STORED INSIDE PEDESTAL HOUSING 36
FIGURE 12 MANHOLE SPLICE STORAGE 37
FIGURE 13 BONDING AND GROUNDING CABLES INSIDE PEDESTALS 38
FIGURE 14 BONDING AND GROUNDING OF LARGE CABLE INSIDE
PEDESTALS USING MULTIPLE SHIELD BOND CONNECTORS
AND HARNESS WIRES 39
FIGURE 15 ALTERNATIVE METHOD OF BONDING AND GROUNDING LARGE
CABLES IN PEDESTALS USING MULTIPLE SHIELD BOND
CONNECTORS AND 6 AWG WIRE BRAID 40
FIGURE 16 ALTERNATIVE METHOD OF BONDING AND GROUNDING SEVERAL
CABLES IN PEDESTALS USING SHIELD BOND CONNECTORS
AND 6 AWG WIRE BRAID LOOP 41
FIGURE 17 GROUNDING SERVICE WIRE SHIELDS USING SERVICE
WIRE CLAMP 42

FIGURE 18 ALTERNATIVE METHOD OF GROUNDING BURIED SERVICE
WIRES INSIDE PEDESTALS 43
FIGURE 19 BONDING AND GROUNDING BURIED FIBER OPTIC SPLICES .. 44

INDEX: Outside Plant
Construction
Splicing
Telecommunications

CFR TO BULLETIN CONVERSION TABLE

7 CFR 1755.200	Bulletin 1753F-401	7 CFR 1755.200	Bulletin 1753F-401
(a)	1.	(d)(3)	4.3
(a)(1)	1.1	(d)(3)(i)	4.3.1
(a)(2)	1.2	(d)(3)(ii)	4.3.2
(a)(3)	1.3	(d)(3)(iii)	4.3.3
(b)	2.	(d)(4)	4.4
(b)(1)	2.1	(d)(4)(i)	4.4.1
(b)(2)	2.2	(d)(4)(ii)	4.4.2
(b)(3)	2.3	(d)(4)(iii)	4.4.3
(b)(4)	2.4	(d)(5)	4.5
(b)(4)(i)	2.4.1	(d)(6)	4.6
(b)(4)(ii)	2.4.2	(d)(7)	4.7
(b)(4)(iii)	2.4.3	(d)(8)	4.8
(b)(4)(iv)	2.4.4	(d)(9)	4.9
(b)(5)	2.5	(d)(10)	4.10
(c)	3.	(d)(10)(i)	4.10.1
(c)(1)	3.1	(d)(10)(ii)	4.10.2
(c)(2)	3.2	(d)(10)(iii)	4.10.3
(c)(3)	3.3	(e)	5.
(c)(3)(i)	3.3.1	(e)(1)	5.1
(c)(3)(ii)	3.3.2	(e)(2)	5.2
(c)(4)	3.4	(e)(3)	5.3
(c)(5)	3.5	(e)(3)(i)	5.3.1
(c)(5)(i)	3.5.1	(e)(3)(ii)	5.3.2
(c)(5)(ii)	3.5.2	(e)(4)	5.4
(c)(5)(iii)	3.5.3	(e)(4)(i)	5.4.1
(c)(5)(iv)	3.5.4	(e)(4)(ii)	5.4.2
(c)(5)(v)	3.5.5	(e)(4)(iii)	5.4.3
(c)(6)	3.6	(e)(4)(iv)	5.4.4
(c)(7)	3.7	(e)(4)(v)	5.4.5
(c)(8)	3.8	(e)(5)	5.5
(c)(8)(i)	3.8.1	(e)(5)(i)	5.5.1
(c)(8)(ii)	3.8.2	(e)(5)(ii)	5.5.2
(c)(8)(iii)	3.8.3	(e)(5)(iii)	5.5.3
(c)(8)(iv)	3.8.4	(e)(6)	5.6
(c)(9)	3.9	(e)(6)(i)	5.6.1
(c)(10)	3.10	(e)(6)(ii)	5.6.2
(c)(11)	3.11	(e)(6)(iii)	5.6.3
(c)(12)	3.12	(e)(6)(iv)	5.6.4
(c)(13)	3.13	(e)(6)(v)	5.6.5
(c)(14)	3.14	(e)(6)(vi)	5.6.6
(c)(14)(i)	3.14.1	(e)(6)(vii)	5.6.7
(c)(14)(ii)	3.14.2	(e)(7)	5.7
(c)(15)	3.15	(e)(7)(i)	5.7.1
(c)(16)	3.16	(e)(7)(ii)	5.7.2
(d)	4.	(e)(7)(iii)	5.7.3
(d)(1)	4.1	(e)(7)(iv)	5.7.4
(d)(1)(i)	4.1.1	(e)(7)(v)	5.7.5
(d)(1)(ii)	4.1.2	(e)(7)(vi)	5.7.6

ABBREVIATIONS

ANSI	American National Standards Institute
AWG	American Wire Gauge
CFR	Code of Federal Regulations
cm	Centimeters
CMR	Communications Riser Cable
dB	Decibels
IEEE	Institute of Electrical and Electronics Engineers, Inc
in.	Inches
mm	Millimeters
NEC	National Electrical Code
NESC	National Electrical Safety Code
NFPA	National Fire Protection Association
OTDR	Optical Time Domain Reflectometer
PIC	Plastic Insulated Conductor
RUS	Rural Utilities Service
SAI	Servicing Area Interface
TE&CM	Telecommunications Engineering and Construction Manual

1. SCOPE

1.1 This standard describes approved methods for splicing plastic insulated copper and fiber optic cables. Typical applications of these methods include aerial, buried, and underground splices.

1.2 Copies of the American National Standard Institute/National Fire Protection Association (ANSI/NFPA) 70, National Electrical Code (NEC), referenced in this standard, can be obtained from NFPA, Batterymarch Park, Quincy, Massachusetts 02269, telephone number 1 (800) 344-3555.

1.3 Copies of the American National Standard Institute/Institute of Electrical and Electronics Engineers, Inc. (ANSI/IEEE), National Electrical Safety Code (NESC), referenced in this standard, can be obtained from IEEE Service Center, 455 Hoes Lane, Piscataway, New Jersey 08854, telephone number 1 (800) 678-4333.

2. GENERAL

2.1 Only Rural Utilities Service (RUS) accepted filled cable and splicing materials shall be used on outside plant projects financed by RUS.

2.2 The installation instructions provided by the manufacturer of splicing materials shall be followed except where those instructions conflict with the procedures specified in this standard.

2.3 Precautions shall be taken to prevent the ingress of moisture and other contaminants during all phases of the splicing installation. When an uncompleted splice must be left unattended, it shall be sealed to prevent the ingress of moisture and other contaminants.

2.4 Minor sheath damage during construction may be repaired if the repair is completed immediately and is approved by the borrower's resident project representative. Minor damage is typically repaired by:

2.4.1 Scuffing the cable sheath associated with the damaged area;

2.4.2 Applying several layers of DR tape over the scuffed and damaged area;

2.4.3 Applying several layers of plastic tape over the DR tape; and

2.4.4 If damage is severe enough to rupture the cable shield, a splice closure shall be installed.

2.5 All splice cases installed on RUS toll trunk and feeder cables shall be filled, whether aerial, buried, or underground.

3. SPLICING CONSIDERATIONS FOR COPPER CABLES

3.1 Preconstruction Testing: It is desirable that each reel of cable be tested for grounds, opens, shorts, crosses, and shield continuity before the cable is installed. However, manufacturer supplied test results are acceptable. All cable pairs shall be free from electrical defects.

3.2 Handling Precautions: The cable manufacturer's instructions concerning pulling tension and bending radius shall be observed. Unless the cable manufacturer's recommendation is more stringent, the minimum bending radius shall be 10 times the cable diameter for copper cables and 20 times the cable diameter for fiber optic cables.

3.3 Cable Sheath Removal:

3.3.1 The length of cable sheath to be removed shall be governed by the type of splicing hardware used. Follow the splice case manufacturer's recommendations. For pedestals or large pair count splice housings, consider removing enough cable sheath to allow the conductors to extend to the top of the pedestal and then hang downward to approximately 15 centimeters (cm) (6 inches (in.)) above the baseplate.

3.3.2 Caution shall be exercised to avoid damaging the conductor insulation when cutting through the cable shield and removing the shield. Sharp edges and burrs shall be removed from the cut end of the shield.

3.4 Shield Bonding and Grounding: For personnel safety, the shields of the cables to be spliced shall be bonded together and grounded before splicing activities are started. (See Paragraphs 7.2, and 7.5.1 through 7.5.3 of this standard for final bonding and grounding provisions.)

3.5 Binder Group Identification:

3.5.1 Color coded plastic tie wraps shall be placed loosely around each binder group of the cables before splicing operations are attempted. The tie wraps shall be installed as near the cable sheath as practicable and shall conform to the same color designations as the binder ribbons. Twisted wire pigtails shall not be used to identify binder groups due to potential transmission degradation.

3.5.2 The standard insulation color code used to identify individual cable pairs within 25-pair binder groups shall be as shown in Table 1:

TABLE 1
Cable Pair Identification Within Binder Groups

<u>Pair No.</u>	<u>Color</u>	
	<u>Tip</u>	<u>Ring</u>
1	White	Blue
2	White	Orange
3	White	Green
4	White	Brown
5	White	Slate
6	Red	Blue
7	Red	Orange
8	Red	Green
9	Red	Brown
10	Red	Slate
11	Black	Blue
12	Black	Orange
13	Black	Green
14	Black	Brown
15	Black	Slate
16	Yellow	Blue
17	Yellow	Orange
18	Yellow	Green
19	Yellow	Brown
20	Yellow	Slate
21	Violet	Blue
22	Violet	Orange
23	Violet	Green
24	Violet	Brown
25	Violet	Slate

3.5.3 The standard binder ribbon color code used to designate 25-pair binder groups within 600-pair super units shall be as shown in Table 2:

TABLE 2
Cable Binder Group Identification

<u>Group No.</u>	<u>Color of Bindings</u>	<u>Group Pair Count</u>
1	White-Blue	1-25
2	White-Orange	26-50
3	White-Green	51-75
4	White-Brown	76-100
5	White-Slate	101-125
6	Red-Blue	126-150
7	Red-Orange	151-175
8	Red-Green	176-200
9	Red-Brown	201-225
10	Red-Slate	226-250
11	Black-Blue	251-275
12	Black-Orange	276-300
13	Black-Green	301-325
14	Black-Brown	326-350
15	Black-Slate	351-375
16	Yellow-Blue	376-400
17	Yellow-Orange	401-425
18	Yellow-Green	426-450
19	Yellow-Brown	451-475
20	Yellow-Slate	476-500
21	Violet-Blue	501-525
22	Violet-Orange	526-550
23	Violet-Green	551-575
24	Violet-Brown	576-600

3.5.4 Super unit binder groups shall be identified in accordance with Table 3:

TABLE 3
Super-Unit Binder Colors

<u>Pair Numbers</u>	<u>Binder Color</u>
1-600	White
601-1200	Red
1201-1800	Black
1801-2400	Yellow
2401-3000	Violet
3001-3600	Blue
3601-4200	Orange
4201-4800	Green
4801-5400	Brown
5401-6000	Slate

3.5.5 Service pairs in screened cables shall be identified in accordance with Table 4:

TABLE 4
Screened Cable Service Pair Identification

<u>Service Pair No.</u>	<u>Color</u>	
	<u>Tip</u>	<u>Ring</u>
1	White	Red
2	White	Black
3	White	Yellow
4	White	Violet
5	Red	Black
6	Red	Yellow
7	Red	Violet
8	Black	Yellow
9	Black	Violet

3.6 Cleaning Conductors: It is not necessary to remove the filling compound from cable conductors before splicing. However, it is permissible to wipe individual conductors with clean paper towels or clean cloth rags. No cleaning chemicals, etc., shall be used. Caution shall be exercised to maintain individual cable pair and binder group identity. Binder group identity shall be maintained by using color coded plastic tie wraps. Individual pair identification shall be maintained by carefully twisting together the two conductors of each pair.

3.7 Expanded Plastic Insulated Conductor (PIC) Precautions: Solid PIC and expanded (foam or foam skin) PIC are spliced in the same manner, using the same tools and materials and, in general, should be treated the same. However, the insulation on expanded PIC is much more fragile than solid PIC. Twisting or forming expanded PIC into extremely compact splice bundles and applying excessive amounts of tension when tightening tie wraps causes shiners and, thus shall be avoided.

3.8 Splice Connectors:

3.8.1 Only RUS accepted filled splice connectors shall be used on outside plant projects financed by RUS.

3.8.2 Specialized connectors are available for splicing operations such as butt splices, in line splices, bridge taps, clearing and capping, and multiple pair splicing operations. The splice connector manufacturer's recommendations shall be followed concerning connector selection and use.

3.8.3 Caution shall be exercised to maintain conductor and pair association both during and after splicing operations.

3.8.4 Splicing operations that involve pairs containing working services shall utilize splice connectors that permit splicing without the interruption of service.

3.9 Piecing Out Conductors: Conductors may be pieced-out to provide additional slack or to repair damaged conductors. However, the conductors shall be pieced-out with conductors having the same gauge and type and color of insulation. The conductors used for piecing-out shall be from cables having RUS acceptance.

3.10 Splice Organization: Spliced pair bundles shall be arranged in firm lay-ups with minimum conductor tension in accordance with the hardware manufacturer's instructions.

3.11 Binder Tape: Perforated nonhygroscopic and nonwicking binder tape should be applied to splices housed in filled splice cases. The binder tape allows the flow of filling compound while holding the splice bundles near the center of the splice case to allow adequate coverage of filling compound.

3.12 Cable Tags: Cables shall be identified by a tag indicating the cable manufacturer's name, cable size, date of placement, and generic route information. Information susceptible to changes caused by future cable throws and rearrangements should not be included. Tags on load coil stubs shall include the serial number of the coil case, the manufacturer's name, and the inductance value.

3.13 Screened Cable: Screened PIC cable is spliced in the same manner as nonscreened PIC cable. However, special considerations are necessary due to differences in the cable design. The transmit and receive bundles of the cable shall be separated and one of the bundles shall be wrapped with shielding material in accordance with the cable manufacturer's recommendations. When acceptable to the cable manufacturer, it is permissible to use either the scrap screening tape removed from the cable during the sheath opening process provided the screening tape is edge coated or new pressure sensitive aluminum foil tape over polyethylene tape.

3.14 Service Wire Connections:

3.14.1 Buried service wires may be spliced directly to cable conductors inside pedestals using the same techniques required for branch cables. Buried service wires may also be terminated on terminal blocks inside pedestals in areas where high service order activity or fixed count cable administration policies require terminal blocks. However, only RUS accepted terminal block equipped with grease or gel filled terminations to provide moisture and corrosion resistance shall be used.

3.14.2 Only filled terminal blocks having RUS acceptance shall be used on aerial service wire connections.

3.15 Copper Cable Testing: Copper cable testing shall be performed in accordance with RUS Bulletin 345-63, RUS Standard for Acceptance Tests and Measurements of Telephone Plant, PC-4.

3.16 Cable Acceptance: Installed cable shall be tested and pass the inventory and acceptance testing specified in the Telephone System Construction Contract (Labor and Materials), RUS Form 515. The tests and inspections shall be witnessed by the borrower's resident project representative. All conductors shall be free from grounds, shorts, crosses, splits, and opens.

4. SPLICE ARRANGEMENTS FOR COPPER CABLES

4.1 Service Distribution Closures:

4.1.1 Ready access closures permit cable splicing activities and the installation of filled terminal blocks for service wire connections in the same closure. Ready access designs shall allow service technicians direct access to the cable core as well as the terminal block.

4.1.2 Fixed count terminals shall restrict service technician access to the cable core. Predetermined cable pairs shall be spliced to the terminal leads or stub cable in advance of service assignments.

4.2 Aerial Splices: Aerial splice cases accommodate straight splices, branch splices, load coils, and service distribution terminals. Aerial splicing arrangements having more than 4 cables spliced in the same splice case are not recommended. Stub cabling to a second splice case to avoid a congested splice is acceptable.

4.3 Buried Splices:

4.3.1 Direct buried splice cases accommodate straight splices, branch splices, and load coils. Direct buried splices shall be filled and shall be used only when above ground splicing inside pedestals is not practicable.

4.3.2 A treated plank or equivalent shall be placed 15 cm (6 in.) above the buried splice case to prevent damage to the splice case from future digging. Where a firm base for burying the splice cannot be obtained, a treated plank or equivalent shall be placed beneath the splice case.

4.3.3 Each buried splice shall be identified for future locating. One method of marking the splice point is the use of a

warning sign. Another method is the burying of an electronic locating device.

4.4 BD-Type Pedestals:

4.4.1 BD-type pedestals are housings primarily intended to house, organize, and protect cable terminations incorporating splice connectors, ground lugs, and load coils. Activities typically performed in pedestals are cable splicing, shield bonding and grounding, loading, and connection of subscriber service drops.

4.4.2 Recommended splice capacities for BD-type pedestals are shown in Table 5. However, larger size pedestals are permissible if service requirements dictate their usefulness. Table 5 is as follows:

TABLE 5
Splice Capacities for BD-Type Pedestals

Pedestal Type	Maximum Straight Splice Pair Capacity Using Single Pair Connectors or Multiple Pair Splice Modules	Maximum Load Splice Pair Capacity Using Single Pair Connectors or Multiple Pair Splice Modules (See Note 1)
BD3, BD3A	100 Pair	50 Pair
BD4, BD4A	200 Pair	100 Pair
BD5, BD5A	600 Pair	300 Pair
BD7	1200 Pair	600 Pair
BD14, BD14A	100 Pair	50 Pair
BD15, BD15A	400 Pair	200 Pair
BD16, BD16A	600 Pair	300 Pair

Note 1: This table refers to load coil cases that are to be direct buried with stub cables extending into the pedestal for splicing. Requirements involving individual coil arrangements inside the pedestal must be engineered on a case-by-case basis.

4.4.3 Special distribution pedestals having a divider plate for mounting filled terminal blocks are available. Distribution pedestals are also equipped with service wire channels for installation of buried service wires without disturbing the cabling and gravel inside the base of the pedestal. Distribution pedestals are recommended in locations where the connection of service wires is required.

4.5 Large Pair Count Splice Housings: Large pair count splice housings are recommended for areas not suitable for manholes. The recommended capacities are shown in Table 6:

TABLE 6
Splice Capacities for Large Pair Count Housings

Housing Type	Maximum Straight Splice Pair Capacity Using Single Pair Connectors or Multiple Pair Splice Modules	Maximum Load Splice Pair Capacity Using Single Pair Connectors or Multiple Pair Splice Modules (See Note 1)
BD 6000	6,000 Pair	3,000 Pair
BD 8000	8,000 Pair	4,000 Pair
BD 10000	10,000 Pair	5,000 Pair

4.6 Pedestal Restricted Access Inserts: Restricted access inserts may be used to protect splices susceptible to unnecessary handling where subsequent work activities are required or expected to occur after splices have been completed. Restricted access inserts also provide moisture protection in areas susceptible to temporary flooding. A typical restricted access insert is shown in Figure 1.

4.7 Serving Area Interface (SAI) Systems: SAI systems provide the cross-connect point between feeder and distribution cables. Connection of feeder to distribution pairs is accomplished by placing jumpers between connecting blocks. Only RUS accepted connecting blocks having grease or gel filled terminations to provide moisture and corrosion resistance shall be used.

4.8 Buried Cable Splicing Arrangements: Typical buried cable splicing arrangements are illustrated in Figures 2 through 5.

4.9 Underground Splices (Manholes): Underground splice cases accommodate straight splices, branch splices, and load coils. Underground splices shall be filled.

4.10 Central Office Tip Cable Splices:

4.10.1 Filled cable or filled splices are not recommended for use in central offices, except in cable vault locations. Outside plant cable sheath and cable filling compound are susceptible to fire and will support combustion. Fire, smoke, and gases generated by these materials during burning are detrimental to telephone switching equipment.

4.10.2 Tip cables should be spliced in a cable vault. However, as a last resort, tip cables may be spliced inside a central

office if flame retardant splice cases or a noncombustible central office splice housing is used to contain the splice.

4.10.3 Splices inside the central office shall be made as close as practical to the point where the outside plant cables enter the building. Except in cable vault locations, outside plant cables within the central office shall be wrapped with fireproof tape or enclosed in noncombustible conduit.

5. SPICING CONSIDERATIONS FOR FIBER OPTIC CABLES

5.1 Connection Characteristics: Splicing efficiency between optical fibers is a function of light loss across the fiber junctions measured in decibels (dB). A loss of 0.2 dB in a splice corresponds to a light transmission efficiency of approximately 95.5 percent.

5.2 Fiber Core Alignment: Fiber splicing techniques shall be conducted in such a manner that the cores of the fibers to be spliced will be aligned as perfectly as possible to allow maximum light transmission from one fiber to the next. Without proper alignment, light will leave the fiber core and travel through the fiber cladding. Light outside the fiber core is not a usable light signal. Core misalignment is illustrated in Figure 6.

5.3 Splice Loss:

5.3.1 Splice loss can also be caused by fiber defects such as nonidentical core diameters, cores not in center of the fiber, and noncircular cores. Such defects are depicted in Figure 7.

5.3.2 Undesirable splice losses are caused by poor splicing techniques including splicing irregularities such as improper cleaves and dirty splices. Typical cleave problems are illustrated in Figure 8.

5.4 Handling Precautions: The following precautions shall be observed:

5.4.1 Avoid damaging the cable during handling operations prior to splicing. Minor damage may change the transmission characteristics of the fibers to the extent that the cable section will have to be replaced;

5.4.2 The cable manufacturer's recommendations concerning pulling tension shall be observed. The maximum pulling tension for most fiber optic cable is 2669 newtons (600 pound-force);

5.4.3 The cable manufacturer's recommendations concerning bending radius shall be observed. Unless the cable manufacturer's recommendation is more stringent, the minimum

bending radius for fiber optic cable shall be 20 times the cable diameter;

5.4.4 The cable manufacturer's recommendations concerning buffer tube bending radius shall be observed. Unless the cable manufacturer's recommendation is more stringent, the minimum bending radius for buffer tubes is usually between 38 millimeters (mm) (1.5 in.) and 76 mm (3.0 in.). The bending limitations on buffer tubes are intended to prevent kinking. Buffer tube kinking may cause excessive optical loss or fiber breakage; and

5.4.5 Handle unprotected glass fibers carefully to avoid introducing flaws such as scratched or broken fibers.

5.5 Personnel Safety: The following safety precautions shall be observed:

5.5.1 Safety glasses shall be worn when handling glass fibers;

5.5.2 Never view open-ended fibers with the naked eye or a magnifying device. Improper viewing of a fiber end that is transmitting light may cause irreparable eye damage; and

5.5.3 Dispose of bare scrap fibers by using the sticky side of a piece of tape to pick up and discard loose fiber ends. Fiber scraps easily penetrate the skin and are difficult to remove.

5.6 Equipment Requirements:

5.6.1 Fiber optic splices shall be made in areas where temperature, humidity, and cleanliness can be controlled. Both fusion and mechanical splicing techniques may require a splicing vehicle equipped with a work station that will allow environmental control.

5.6.2 Both fusion and mechanical splicing techniques are permitted on RUS financed projects. When using the mechanical splicing technique, only RUS accepted mechanical fiber optic splice connectors can be used.

5.6.3 Fusion splicing machines shall be kept in proper working condition. Regular maintenance in accordance with the machine manufacturer's recommendations shall be observed.

5.6.4 Mechanical splicing tools shall be in conformance with the tool manufacturer's recommendations.

5.6.5 An optical time domain reflectometer (OTDR) shall be used for testing splices. The OTDR shall be stationed at the central office or launch point for testing individual splices as they are made and for end-to-end signature tests for the fiber optic link.

5.6.6 An optical power meter shall be used for end-to-end cable acceptance tests.

5.6.7 A prerequisite for the successful completion of a fiber optic splicing endeavor is the presence of a talk circuit between the splicing technician in the splicing vehicle and the operator of the OTDR in the central office. The splicing technician and the OTDR operator shall have access to communications with each other to inform each other as to:

- a. Which splices meet the loss objectives;
- b. The sequence in which buffer tubes and fibers are to be selected for subsequent splicing operations; and
- c. The timing required for the performance of OTDR testing to prevent making an OTDR test at the same time a splice is being fused.

5.7 Cable Preparation:

5.7.1 The engineering work prints shall prescribe the cable slack needed at splice points to reach the work station inside the splicing vehicle. Consideration should be given to the slack required for future maintenance activity as well as initial construction activities. The required slack may be different for each splice point, depending on the site logistics. However, the required slack is seldom less than 15 meters (50 feet). The amount of slack actually used shall be recorded for each splice point to assist future maintenance and restoration efforts.

5.7.2 The splice case manufacturer's recommendations concerning the amount of cable sheath to be removed shall be followed to facilitate splicing operations. The length of the sheath opening shall be identified with a wrap of plastic tape.

5.7.3 If the cable contains a rip cord, the cable jacket shall be ring cut approximately 15 cm (6 in.) from the end and the 15 cm (6 in.) of cable jacket shall be removed to expose the rip cord. The rip cord shall be used to slit the jacket to the tape mark.

5.7.4 If the cable does not contain rip cord, the cable jacket shall be slit using a sheath splitter. No cuts shall be made into the cable core nor shall the buffer tubes be damaged.

5.7.5 If the cable contains an armor sheath, the outer jacket shall be opened along the slit and the jacket shall be removed exposing the armor sheath. The armor shall be separated at the seam and pulled from the cable exposing the inner jacket. The armor shall be removed making allowances for a shield bond connector. The inner sheath shall be slit using a sheath

splitter or rip cord. The cable core shall not be damaged nor shall there be any damage to the buffer tubes. The jacket shall be peeled back and cut at the end of the slit. The exposed buffer tubes shall not be cut, kinked, or bent.

5.7.6 After the cable sheath has been removed, the binder tape shall be removed from the cable. The cable shall not be crushed or deformed.

5.7.7 The buffer tubes shall be unstranded one at a time. The buffer tubes shall not be kinked.

5.7.8 If the cable is equipped with a strength member, the strength member shall be cut to the length recommended by the splice case manufacturer.

5.7.9 Each buffer tube shall be inspected for kinks, cuts, and flat spots. If damage is detected, an additional length of cable jacket shall be removed and all of the buffer tubes shall be cut off at the point of damage.

5.7.10 The cable preparation sequence shall be repeated for the other cable end.

5.8 Shield Bonding and Grounding: For personnel safety, the shields and metallic strength members of the cables to be spliced shall be bonded together and grounded before splicing activities are started. (See Paragraphs 7.4, and 7.5.1 through 7.5.3 of this standard for final bonding and grounding provisions.)

5.9 Fiber Optic Color Code: The standard fiber optic color code for buffer tubes and individual fibers shall be as shown in Table 7.

TABLE 7
Fiber and Buffer Tube Identification

<u>Buffer Tube and Fiber No.</u>	<u>Color</u>
1	Blue
2	Orange
3	Green
4	Brown
5	Slate
6	White
7	Red
8	Black
9	Yellow
10	Violet
11	Rose
12	Aqua
13	Blue/Black Tracer

14	Orange/Black Tracer
15	Green/Black Tracer
16	Brown/Black Tracer
17	Slate/Black Tracer
18	White/Black Tracer
19	Red/Black Tracer
20	Black/Yellow Tracer
21	Yellow/Black Tracer
22	Violet/Black Tracer
23	Rose/Black Tracer
24	Aqua/Black Tracer

5.10 Buffer Tube Removal:

5.10.1 The splice case manufacturer's recommendation shall be followed concerning the total length of buffer tube to be removed. Identify the length to be removed with plastic tape.

5.10.2 Experiment with a scrap buffer tube to determine the cutting tool adjustment required to ring cut a buffer tube without damaging the fibers.

5.10.3 Buffer tubes shall be removed by carefully ring cutting and removing approximately 15 to 46 cm (6 to 18 in.) of buffer tube at a time. The process shall be repeated until the required length of buffer tube has been removed, including the tape identification marker.

5.11 Coated Fiber Cleaning:

5.11.1 Each coated fiber shall be cleaned. The cable manufacturer's recommendations shall be followed concerning the solvent required to clean the coated fibers. Reagent grade isopropyl alcohol is a commonly used cleaning solvent.

5.11.2 A tissue or cotton ball shall be soaked in the recommended cleaning solvent and the coated fibers shall be carefully wiped one at a time using a clean tissue or cotton ball for each coated fiber. Caution shall be exercised to avoid removing the coloring agent from the fiber coating.

5.12 Fiber Coating Removal:

5.12.1 Fiber coatings shall be removed. In accordance with the splicing method used, the splice case manufacturer's recommendation shall be followed concerning the length of fiber coating to be removed.

5.12.2 The recommended length of fiber coating shall be removed only on the two fibers to be spliced. Fiber coating removal

shall be performed on a one-fiber-at-a-time basis as each splice is prepared.

5.13 Bare Fiber Cleaning: After the fiber coating has been removed, the bare fibers shall be cleaned prior to splicing. Each fiber shall be wiped with a clean tissue or cotton ball soaked with the cleaning solvent recommended by the cable manufacturer. The bare fiber shall be wiped one time to minimize fiber damage. Aggressive wiping of bare fiber shall be avoided as it lowers the fiber tensile strength.

5.14 Fiber Cleaving: Cleaving tools shall be clean and have sharp cutting edges to minimize fiber scratches and improper cleave angles. Cleaving tools that are recommended by the manufacturer of the splicing system shall be used.

5.15 Cleaved Fiber Handling: The cleaved and cleaned fiber shall not be allowed to touch other objects and shall be inserted into the splicing device.

5.16 Completion of the Splice:

5.16.1 In accordance with the method of splicing selected by the borrower, the splice shall be completed by either fusing the splice or by applying the mechanical connector.

5.16.2 Each spliced fiber shall be routed through the organizer tray one at a time as splices are completed. The fibers shall be organized one at a time to prevent tangled spliced fibers. The splice case manufacturer's recommendation shall be followed concerning the splice tray selection.

5.17 Fiber Optic Testing: Fiber optic testing shall be performed in accordance with RUS Bulletin 345-63, RUS Standard For Acceptance Tests and Measurements of Telephone Plant, PC-4.

5.18 Cable Acceptance: Installed cable shall be tested and pass the inventory and acceptance testing specified in the Telephone System Construction Contract (Labor and Materials), RUS Form 515. The tests and inspections shall be witnessed by the borrower's resident project representative.

6. SPLICE ARRANGEMENTS FOR FIBER OPTIC CABLES

6.1 Aerial Splices: Cable slack at aerial splices shall be stored either on the messenger strand, on the pole, or inside a pedestal at the base of the pole. A typical arrangement for the storage of cable slack at aerial splices is shown in Figure 9.

6.2 Buried Splices: Buried splices shall be installed in handholes to accommodate the splice case and the required splicing slack. An alternative to the handhole is a pedestal

specifically designed for fiber optic splice cases. Typical arrangements for buried cable splices are shown in Figures 10 and 11.

6.3 Underground Manhole Splices: Underground splices shall be stored in manholes on cable hooks and racks fastened to the manhole wall. The cable slack shall be stored on cable hooks and racks as shown in Figure 12.

6.4 Central Office Cable Entrance:

6.4.1 Filled cable or filled splices are not recommended for use inside the central offices except in cable vault locations. Outside plant cable sheath and cable filling compound are susceptible to fire and will support combustion. Fire, smoke, and gases generated by these materials during burning are detrimental to telephone switching equipment.

6.4.2 As a first choice, the outside plant fiber optic cable shall be spliced to an all-dielectric fire retardant cable in a cable vault with the all-dielectric cable extending into the central office and terminated inside a fiber patch panel.

6.4.3 As a second choice, the outside plant cable may be spliced inside the central office if a flame retardant fiber optic splice case or a noncombustible central office splice housing equipped with organizer trays is used to contain the splice.

6.4.4 In cases referenced in Paragraphs 6.4.2 and 6.4.3 of this standard, as a minimum the fire retardant all-dielectric cable used to provide the connection between the cable entrance splice and the fiber patch panel shall be listed as Communication Riser Cable (Type CMR) in accordance with Sections 800-50 and 800-51(b) of the 1993 National Electrical Code.

6.4.5 Splices inside the central office shall be made as close as practicable to the point where the outside plant cables enter the building. Except in cable vault locations, outside plant cables within the central office shall be wrapped with fireproof tape or enclosed in noncombustible conduit.

7. BONDING AND GROUNDING FIBER OPTIC CABLE, COPPER CABLE, AND COPPER SERVICE WIRE

7.1 Bonding: Bonding is electrically connecting two or more metallic items of telephone hardware to maintain a common electrical potential. Bonding may involve connections to another utility.

7.2 Copper Cable Shield Bond Connections:

7.2.1 Cable shields shall be bonded at each splice location. Only RUS accepted cable shield bond connectors shall be used to provide bonding and grounding connections to metallic cable shields. The shield bond connector manufacturer's instructions shall be followed concerning installation and use.

7.2.2 Shield bonding conductors shall be either stranded or braided tinned copper wire equivalent to a minimum No. 6 American Wire Gauge (AWG) and shall be RUS accepted. The conductor connections shall be tinned or of a compatible bimetallic design to avoid corrosion problems associated with dissimilar metals. The number of shield bond connectors required per pair size and gauge shall be as shown in Table 8:

TABLE 8
Shield Bond Connectors Per Pair Size and Gauge

<u>19 AWG</u>	<u>Pair Size and Gauge</u>		<u>26 AWG</u>	<u>No. of Shield Bond Connectors</u>
	<u>22 AWG</u>	<u>24 AWG</u>		
0-25	0-100	0-150	0-200	1
50-100	150-300	200-400	300-600	2
150-200	400-600	600-900	900-1500	3
300-600	900-1200	1200-2100	1800-3600	4

7.2.3 It is permissible to strap across the shield bond connectors of several cables with a single length of braided wire. However, both ends of the braid shall be terminated on the pedestal ground bracket to provide a bonding loop. Shield bond connection methods for individual cables are shown in Figures 13 through 15, and the bonding of several cables inside a pedestal using the bonding loop is shown in Figure 16.

7.3 Buried Service Wire Shield Bond Connections: Buried service wire shields shall be connected to the pedestal bonding and grounding system. Typical buried service wire installations are shown in Figures 17 and 18. In addition to the methods referenced in Figures 17 and 18, the shields of buried service wires may also be connected to the pedestal bonding and grounding system using buried service wire bonding harnesses listed on Page 3.3.1, Item "gs-b," of RUS Bulletin 1755I-100. RUS Bulletin 1755I-100 may be purchased from the Superintendent of Documents, U.S. Government Printing Office, Washington, DC 20402. When those harnesses are used they shall be installed in accordance with the manufacturer's instructions.

7.4 Fiber Optic Cable Bond Connections:

7.4.1 The cable shield and metallic strength members shall be bonded at each splice location. Only RUS accepted fiber optic cable shield bond connectors shall be used to provide bonding connections to the metallic cable shields. The shield bond connector manufacturer's instructions shall be followed concerning installation and use.

7.4.2 Shield bonding conductors shall be either stranded or braided tinned copper wire equivalent to a minimum No. 6 AWG and shall be RUS accepted. The conductor connections shall be tinned or of a compatible bimetallic design to avoid corrosion problems associated with dissimilar metals.

7.5 Grounding:

7.5.1 Grounding is electrically connecting metallic telephone hardware to a National Electrical Safety Code (NESC) acceptable grounding electrode. Acceptable grounding electrodes are defined in the Rule 99A of the NESC.

7.5.2 The conductor used for grounding metallic telephone hardware shall be a minimum No. 6 AWG solid, bare copper conductor.

7.5.3 For copper and fiber optic cable plant, all cable shields, all metallic strength members, and all metallic hardware shall be:

7.5.3.1 Grounded at each splice location to a driven grounding electrode (ground rod) of:

- a. At least 1.5 meters (5 feet) in length where the local frost level is normally less than 0.30 meters (1 foot) deep; or
- b. At least 2.44 meters (8 feet) in length where the local frost level is normally 0.30 meters (1 foot) or deeper; and

7.5.3.2 Bonded to a multi-grounded power system neutral when the splice is within 1.8 meters (6 feet) of access to the grounding system of the multi-grounded neutral system. Bonding to the multi-grounded neutral of a parallel power line may help to minimize telephone interference on long exposures with copper cable plant. Consideration, thus, should be given to completing such bonds, at least four (4) times each mile, when splices are greater than 1.8 meters (6 feet) but less than 4.6 meters (15 feet) from access to the multi-grounded neutral.

7.6 Bonding and Grounding Splice Cases:

7.6.1 Splice cases are equipped with bonding and grounding devices to ensure that cable shields and metallic strength members maintain electrical continuity during and after cable splicing operations. The splice case manufacturer's recommendations shall be followed concerning the bonding and grounding procedures. Conductors used for bonding shall be either stranded or braided tinned copper wire equivalent to 6 AWG. Conductors used for grounding shall be a solid, bare, copper wire equivalent to minimum No. 6 AWG.

7.6.2 Buried splice cases installed in either handholes or pedestals shall be grounded such that the cable shield grounds are attached to a common ground connection that will allow the lifting of a ground on the cable shield in either direction to permit efficient cable locating procedures. As a first choice, buried grounding conductor(s) shall be bare. However, if two or more grounding conductors are buried in the same trench, they shall be insulated to avoid shorts when a locating tone is applied.

7.6.3 A typical bonding and grounding method for fiber optic splices is shown in Figure 19.

7.7 Bonding and Grounding Central Office Cable Entrances: The RUS Telecommunications Engineering and Construction Manual (TE&CM) Section 810 provides bonding and grounding guidance for central office cable entrances. Splicing operations shall not be attempted before all metallic cable shield and strength members are bonded and grounded.

FIGURE 1

PEDESTAL RESTRICTED ACCESS INSERT

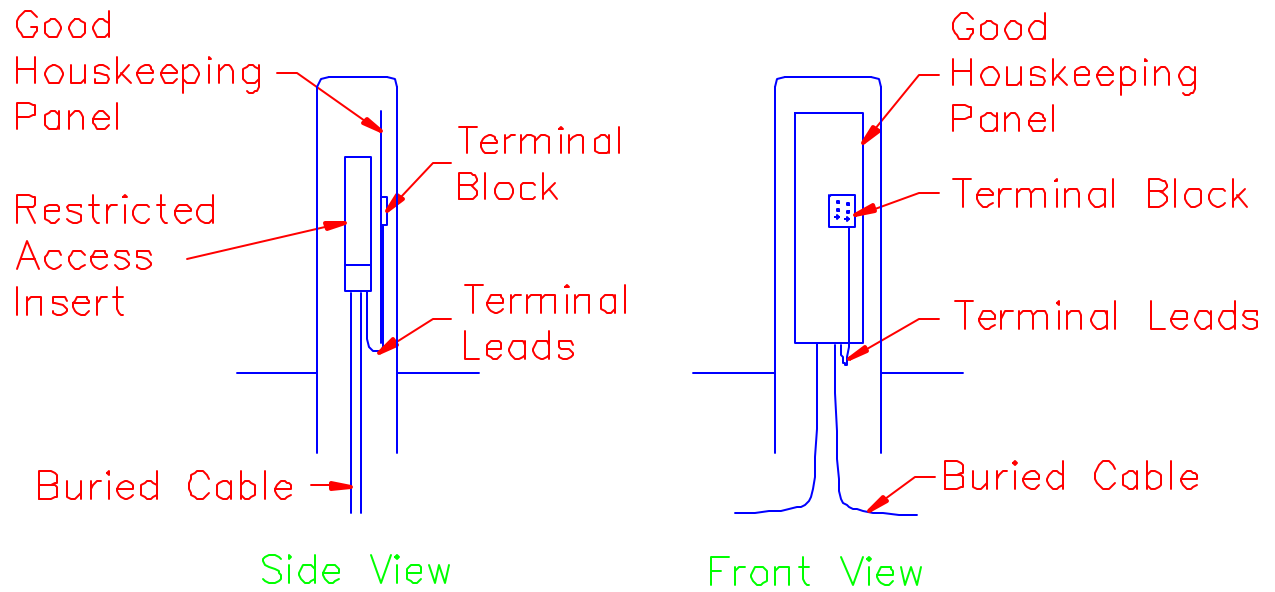
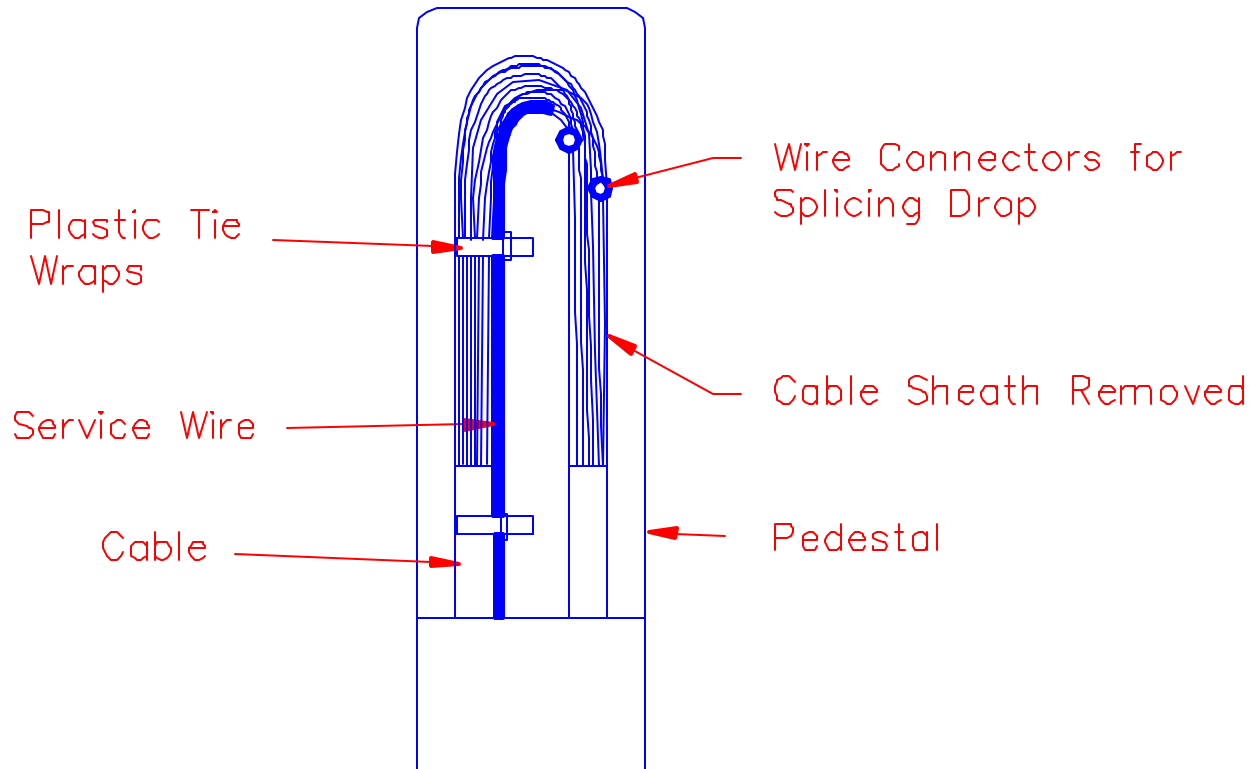

FIGURE 2
SERVICE WIRE CONNECTION TO BURIED CABLE



Note: See Figures 13 through 16 for cable tags, tie wraps, and bonding and grounding details.

FIGURE 3

TYPICAL SPLICE USING SINGLE PAIR CONNECTORS

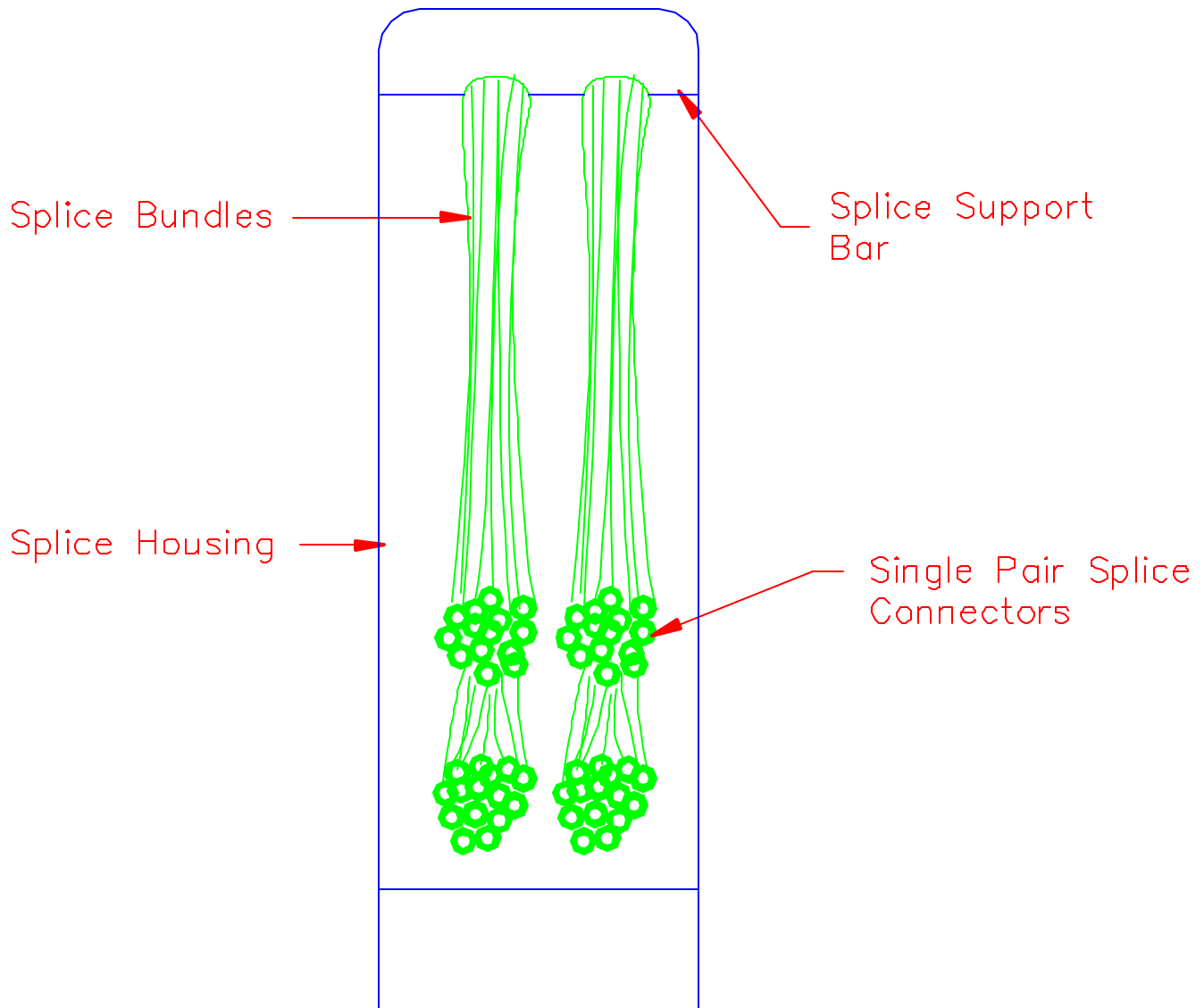

Note: Cable tags, bonding and grounding details, and plastic tie wraps have been omitted for clarity. See Figures 13 through 16 for cable tags, tie wraps, and bonding and grounding details.

FIGURE 4

LARGE SPLICE USING MULTIPLE PAIR CONNECTORS

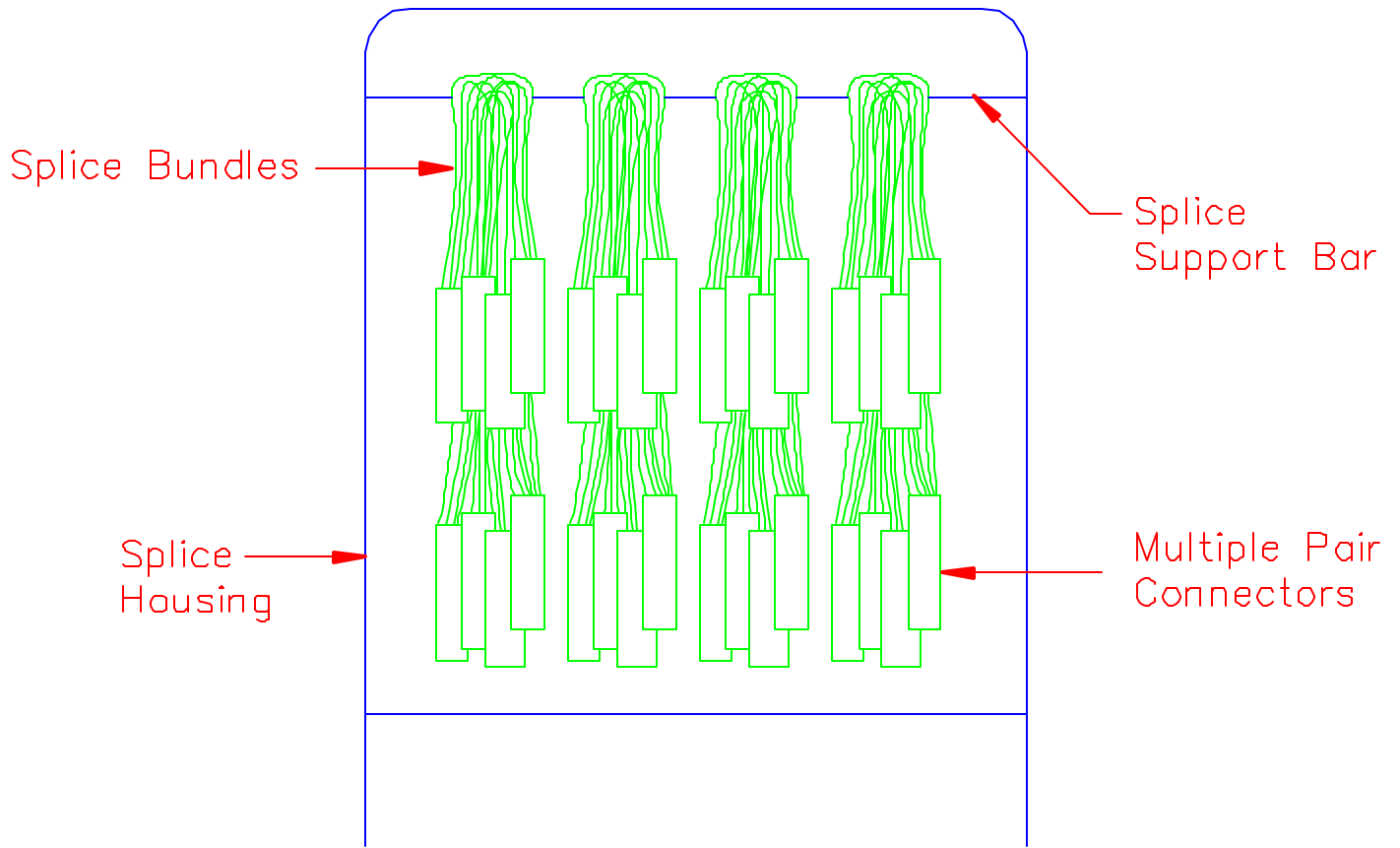

Note: Cable tags, bonding and grounding details, and plastic tie wraps have been omitted for clarity. See Figures 13 through 16 for cable tags, tie wraps, and bonding and grounding details.

FIGURE 5

LARGE SPLICE USING MULTIPLE PAIR CONNECTORS
MOUNTED ON ORGANIZER RACKS

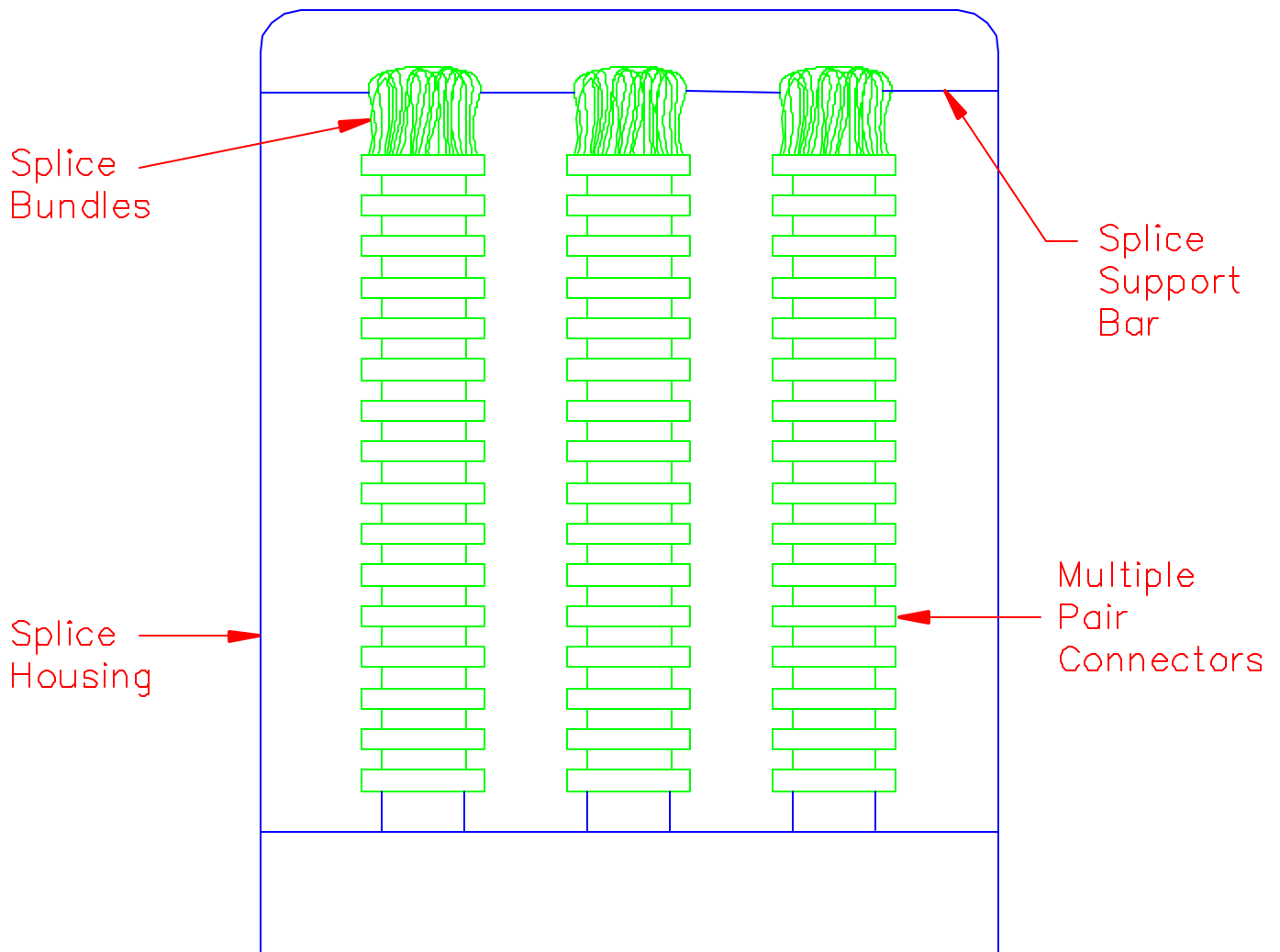

Note: Cable tags, bonding and grounding details, and plastic tie wraps have been omitted for clarity. See Figures 13 through 16 for cable tags, tie wraps, and bonding and and grounding details.

FIGURE 6
CORE MISALIGNMENT

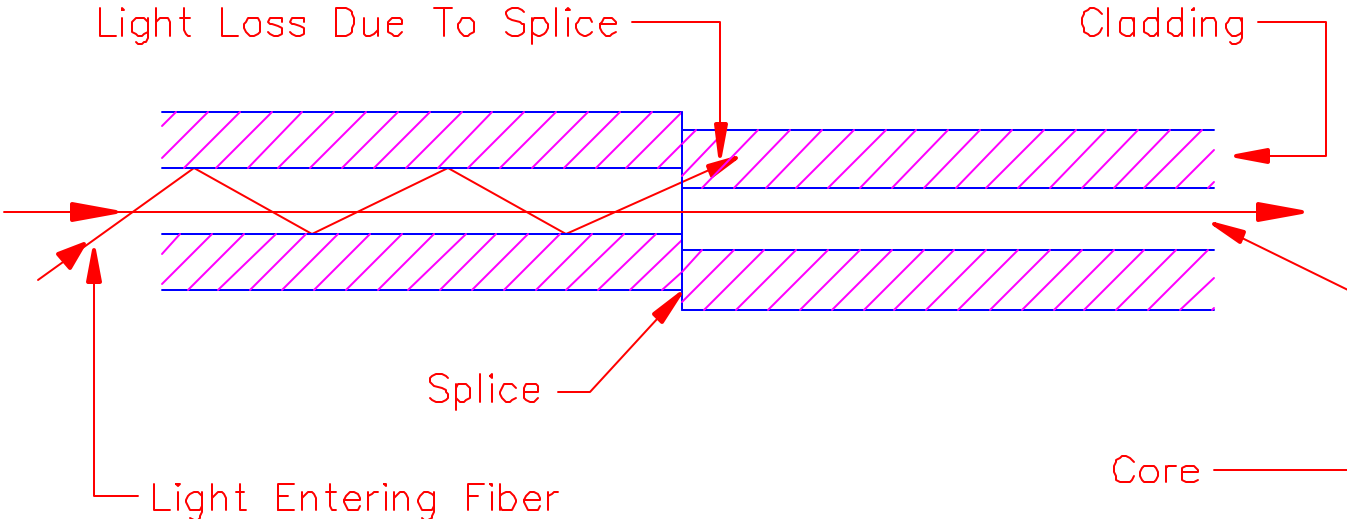
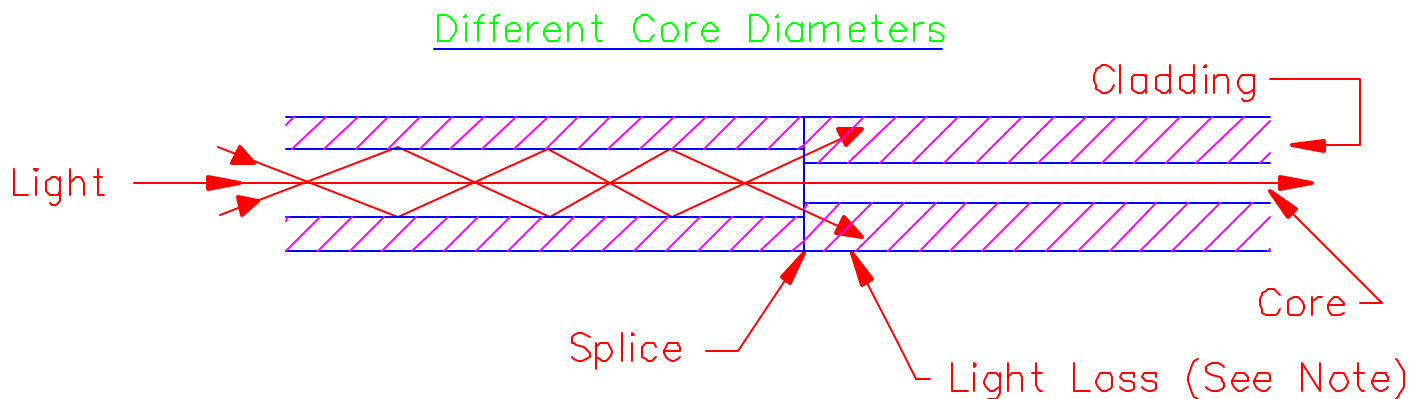

FIGURE 7
SPLICE LOSS CAUSED BY FIBER MANUFACTURE



Note: There is no light loss if the light travels from a smaller to a larger core.

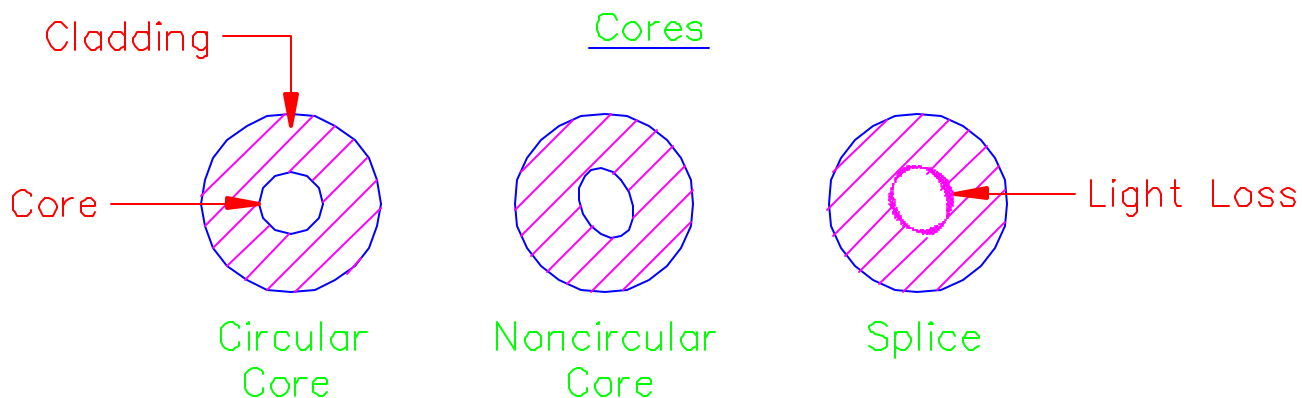
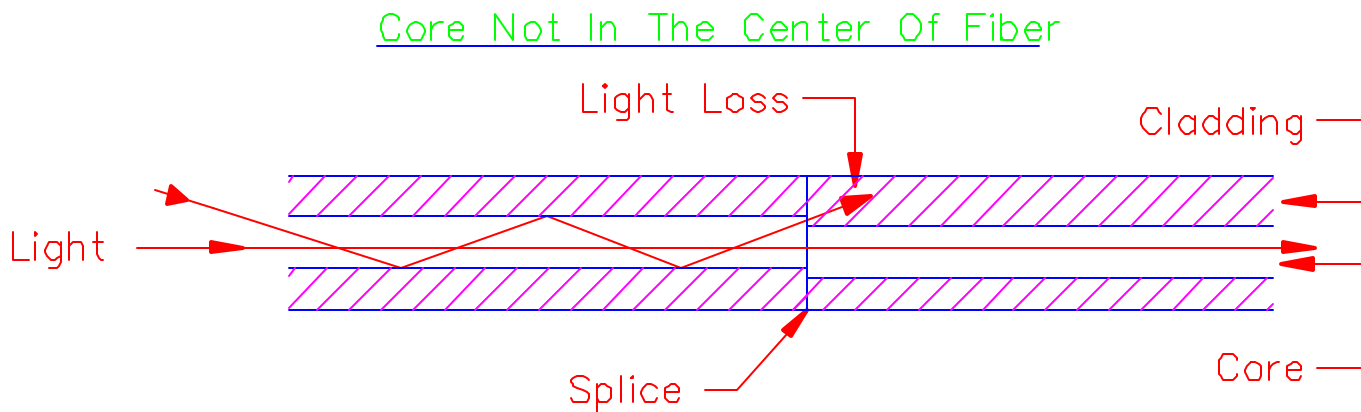
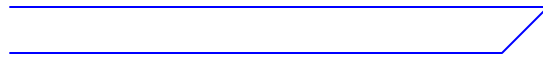
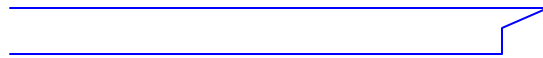

FIGURE 8
IMPROPER CLEAVES VERSUS PROPER CLEAVE



Angled End



End Spur

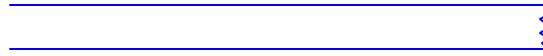

Fractured End

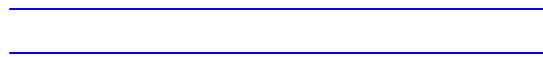

Properly Cleaved Fiber

FIGURE 9
AERIAL SPLICE STORED INSIDE PEDESTAL

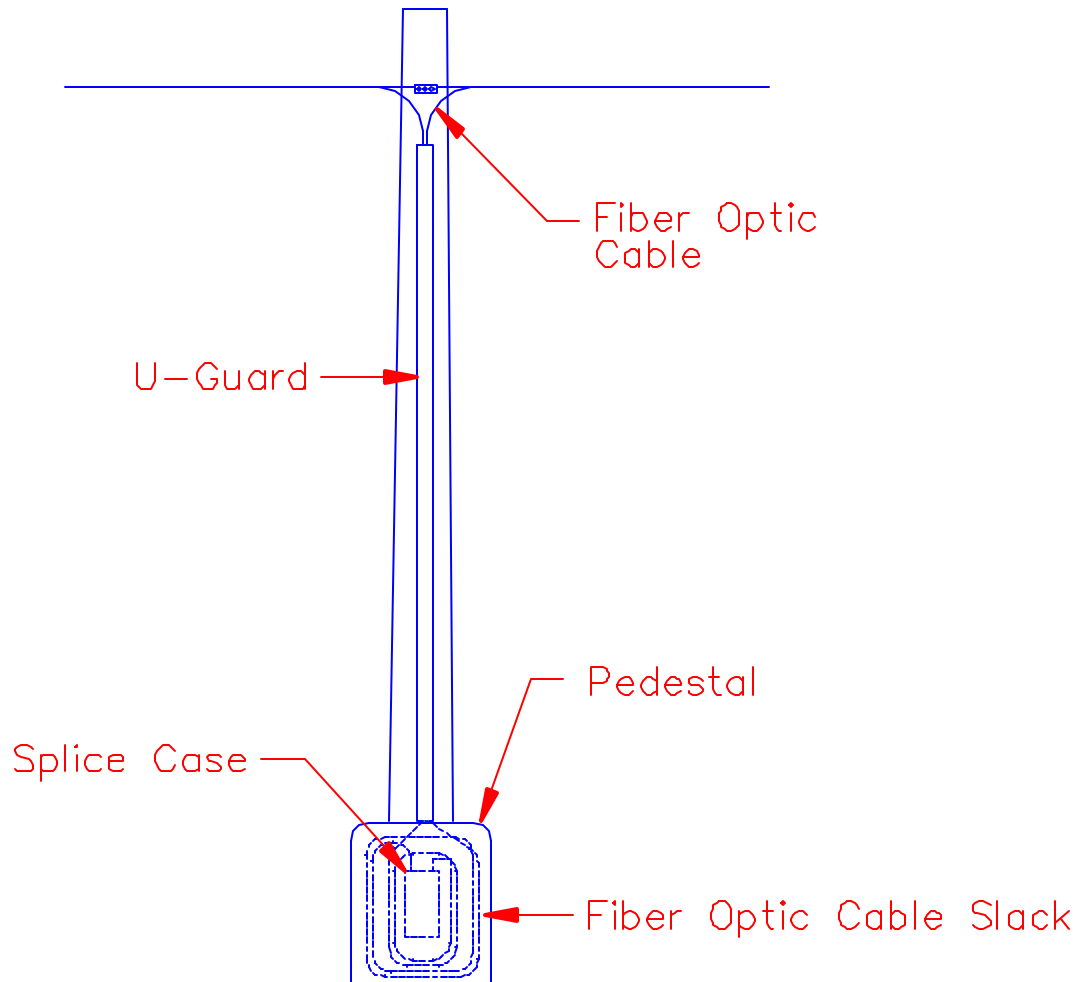

Note: See Figure 11 for details concerning storage of splice case inside pedestal.

FIGURE 10
BURIED SPLICE STORED INSIDE HANDHOLE

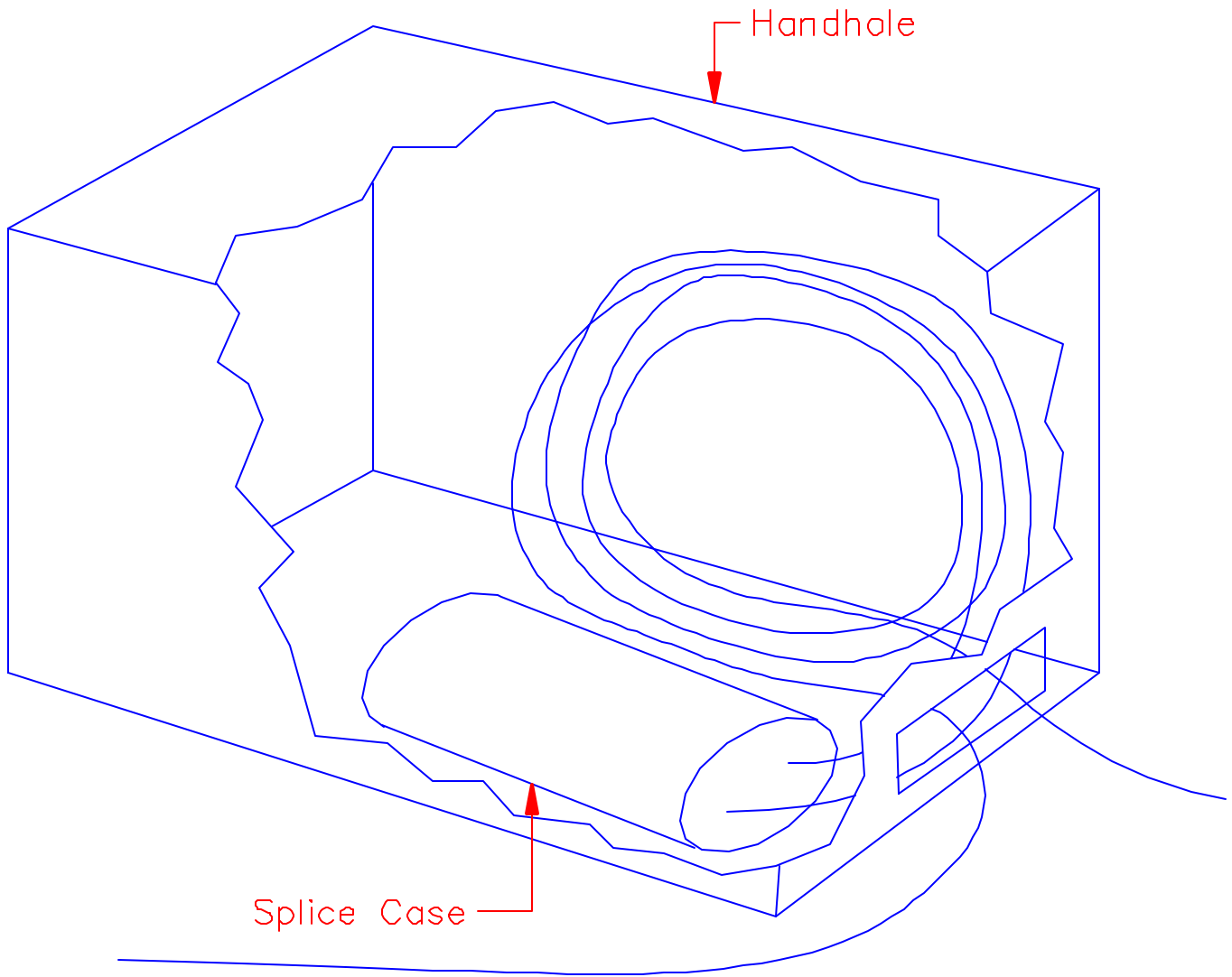

Note: Ground wires omitted for clarity. See Figure 19 for bonding and grounding details.

FIGURE 11
BURIED SPLICE STORED INSIDE PEDESTAL HOUSING

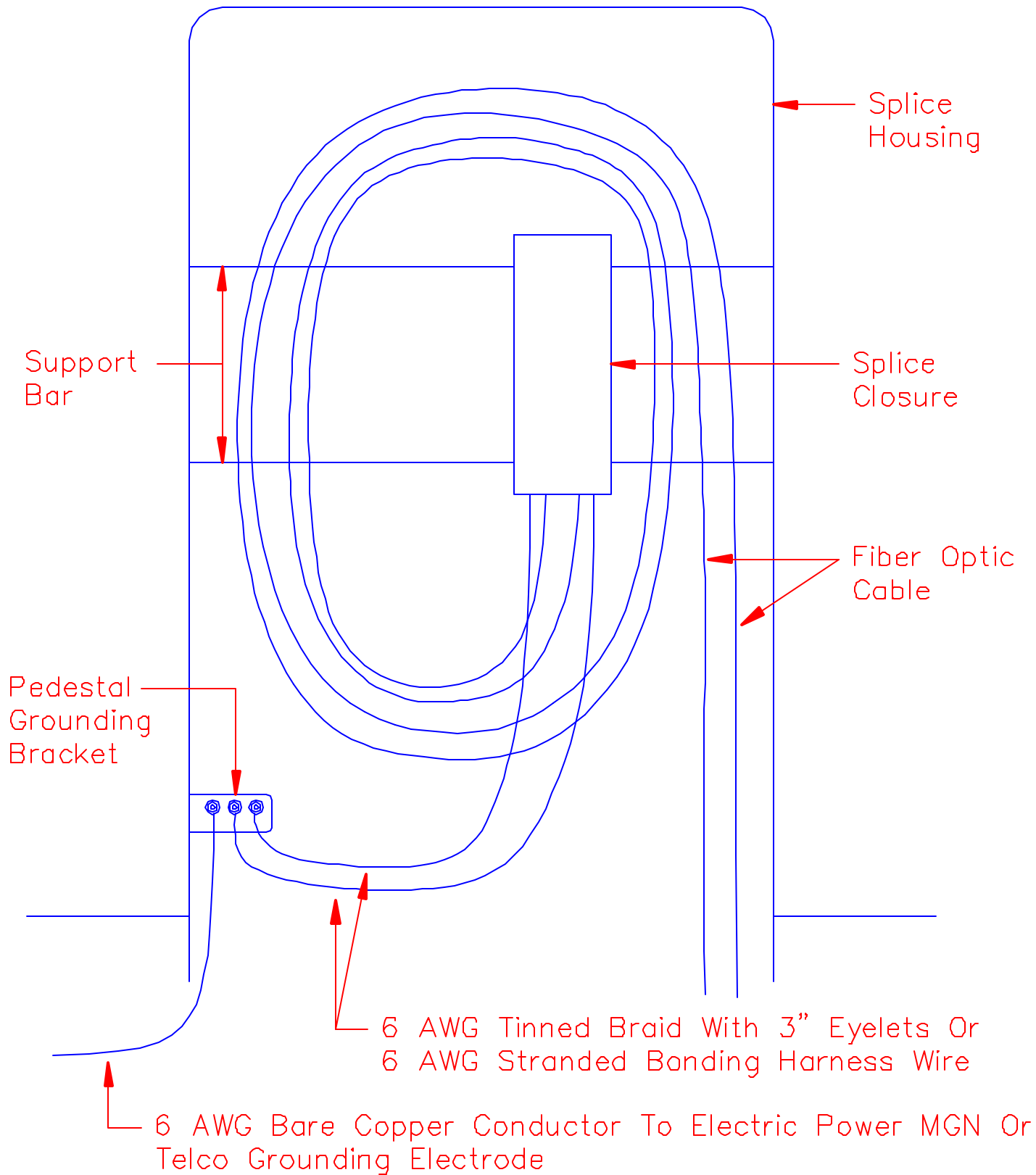

FIGURE 12
MANHOLE SPLICE STORAGE

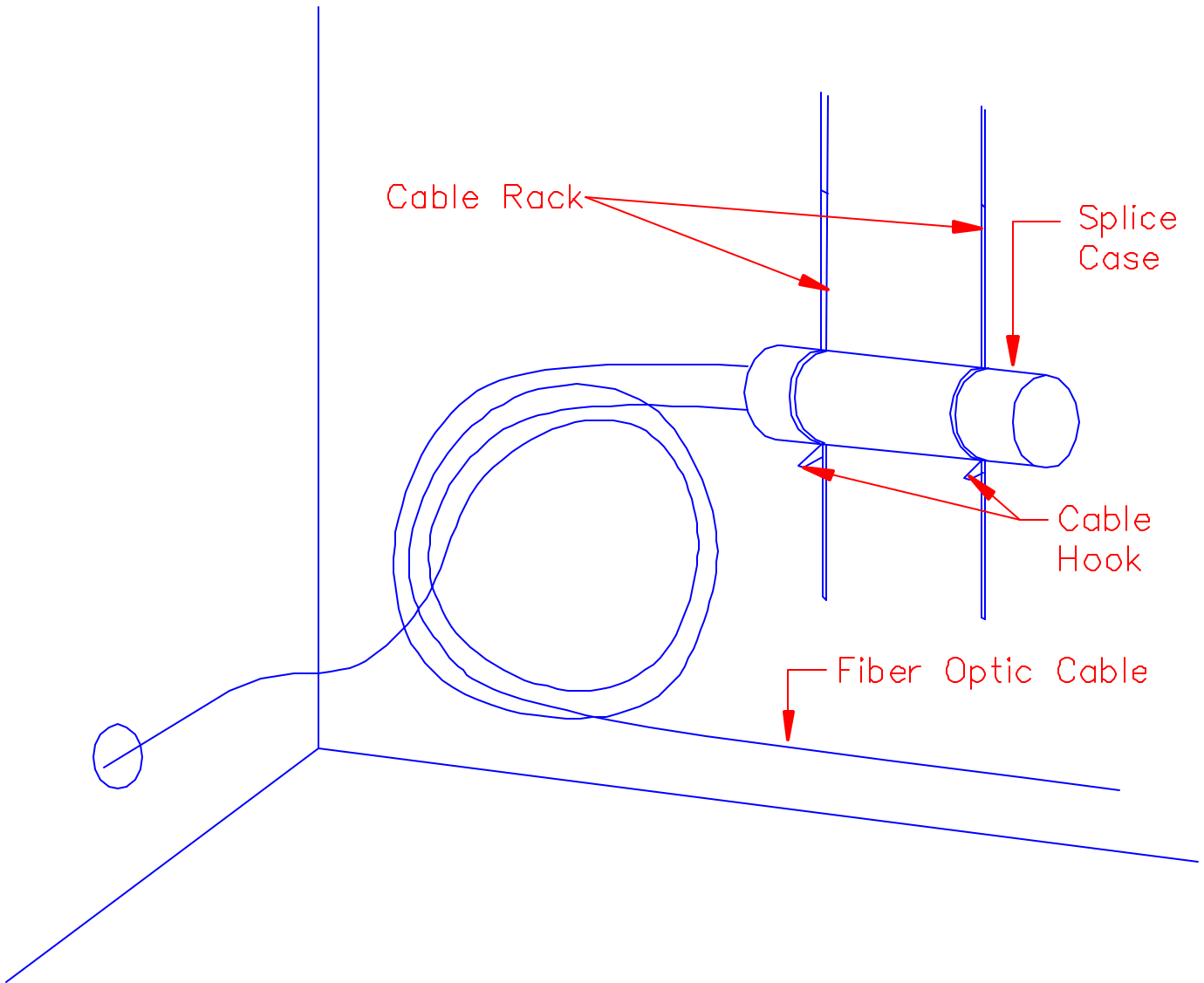

FIGURE 13
BONDING AND GROUNDING CABLES INSIDE PEDESTALS

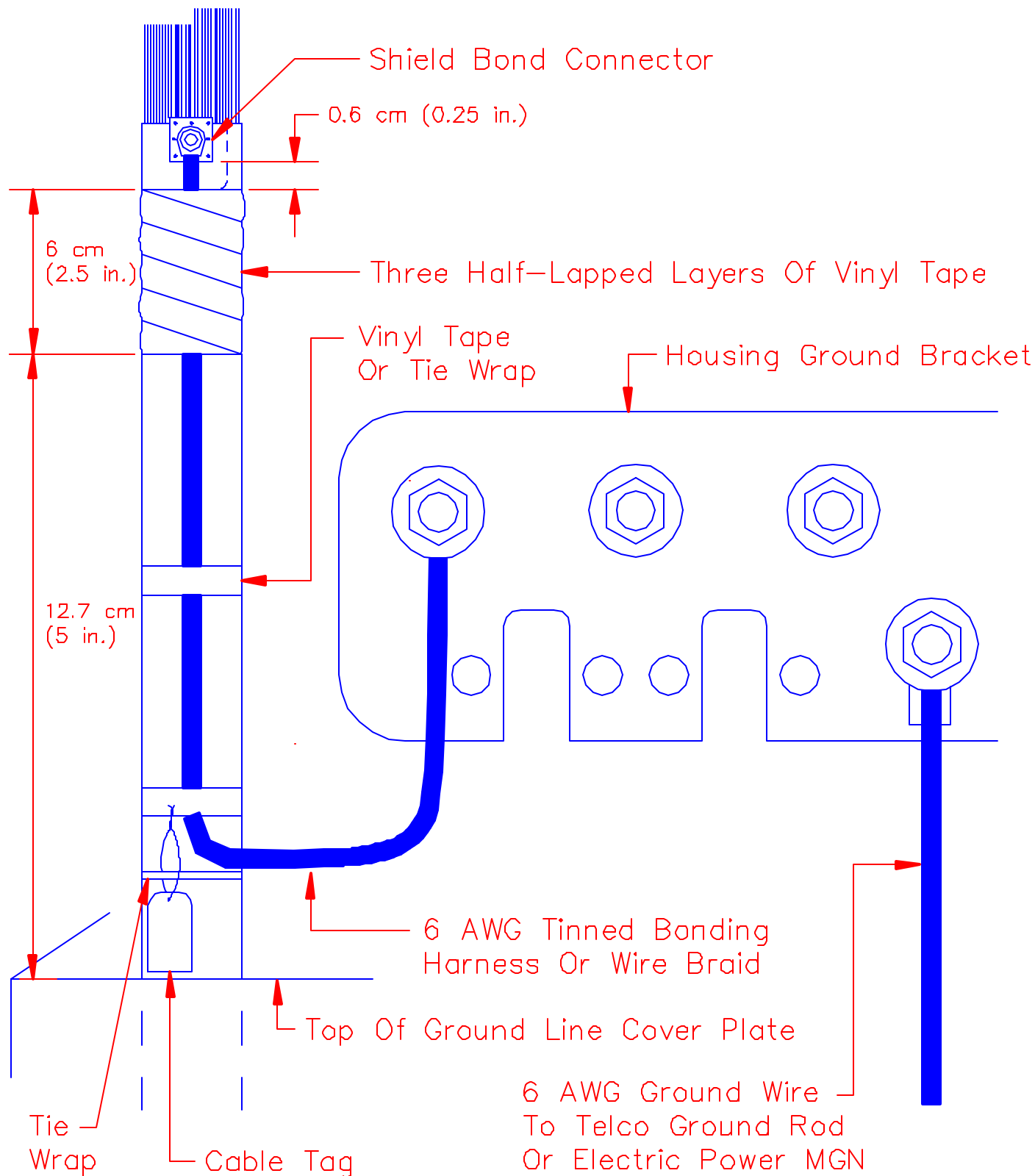
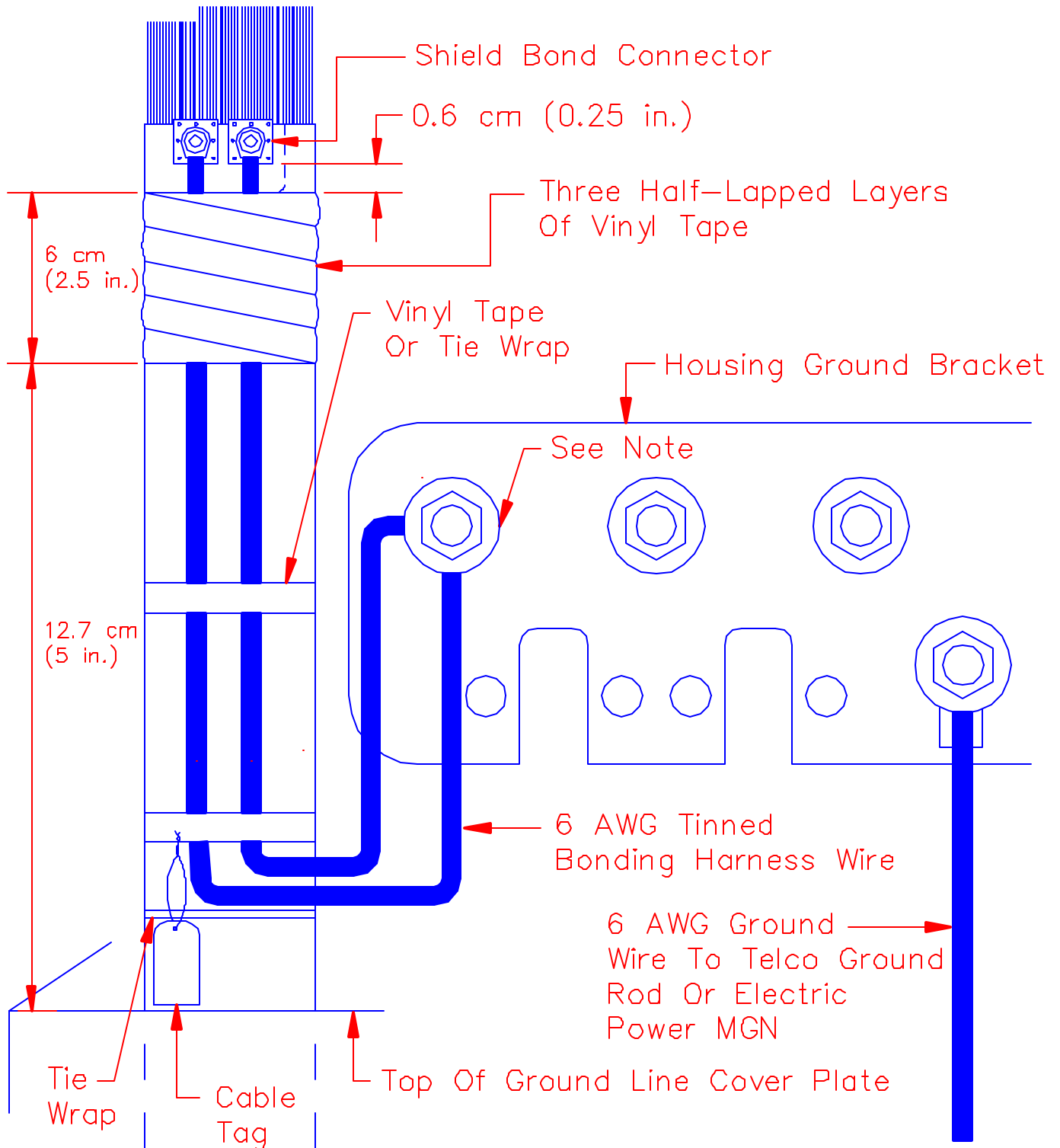

FIGURE 14

BONDING AND GROUNDING OF LARGE CABLES INSIDE PEDESTALS USING MULTIPLE SHIELD BOND CONNECTORS AND HARNESS WIRES



Note: The maximum number of harness wires that can be installed on each stud of the ground bracket shall be in accordance with the manufacturer's instructions.

FIGURE 15

ALTERNATIVE METHOD OF BONDING AND GROUNDING LARGE CABLES
IN PEDESTALS USING MULTIPLE SHIELD BOND CONNECTORS AND
6 AWG WIRE BRAID

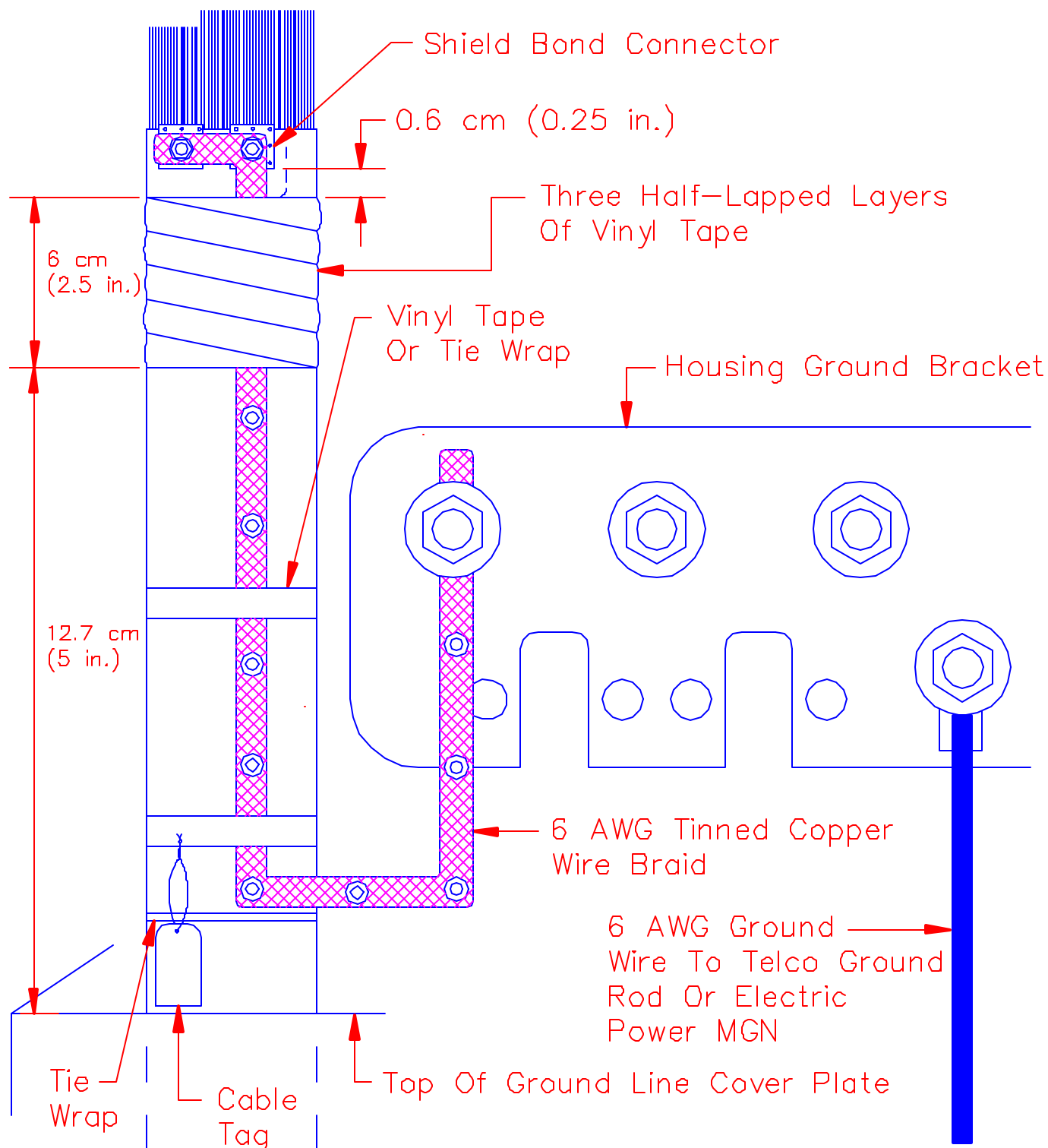

FIGURE 16

ALTERNATIVE METHOD OF BONDING AND GROUNDING SEVERAL CABLES IN PEDESTALS USING SHIELD BOND CONNECTORS AND 6 AWG WIRE BRAID LOOP

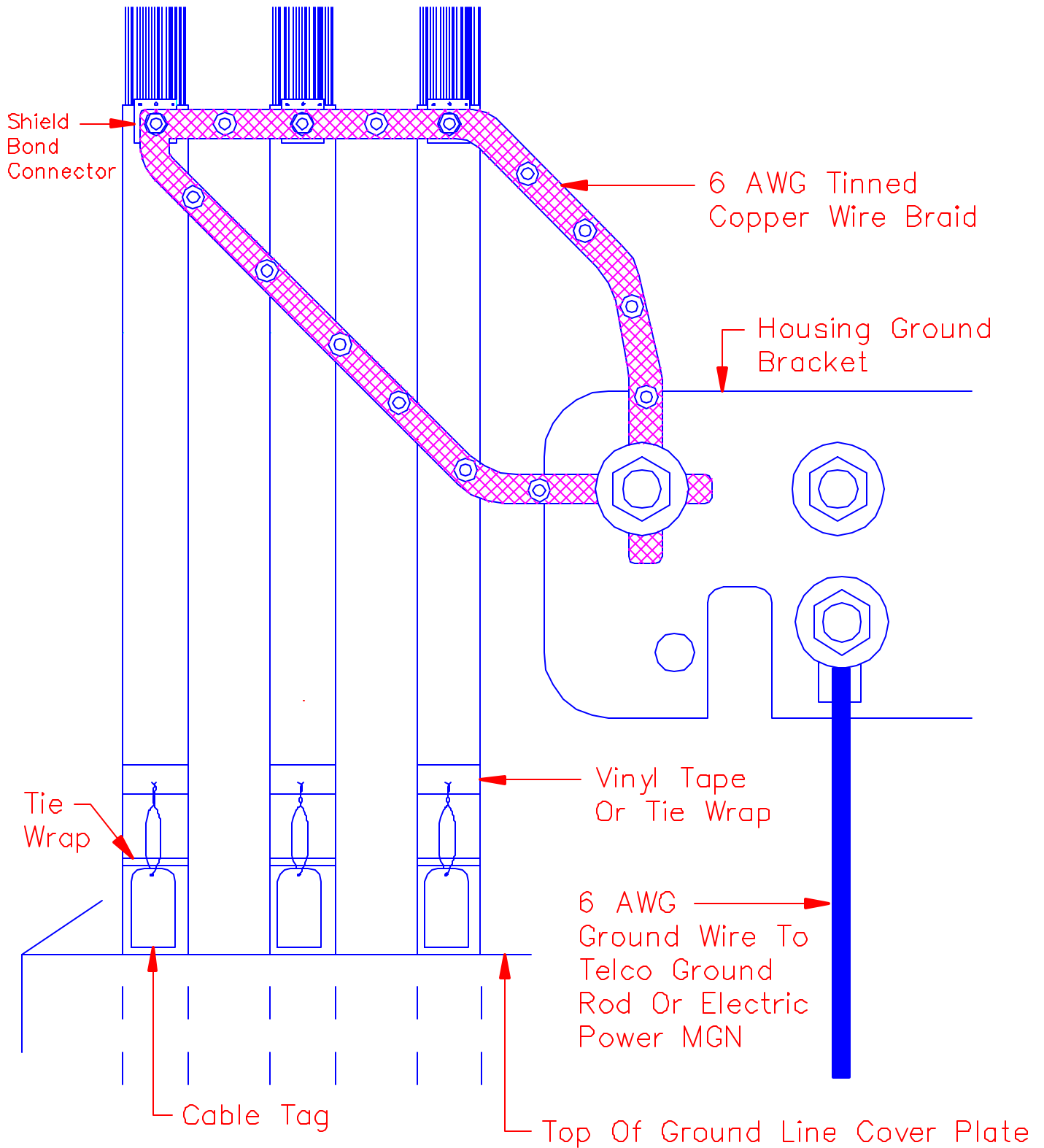
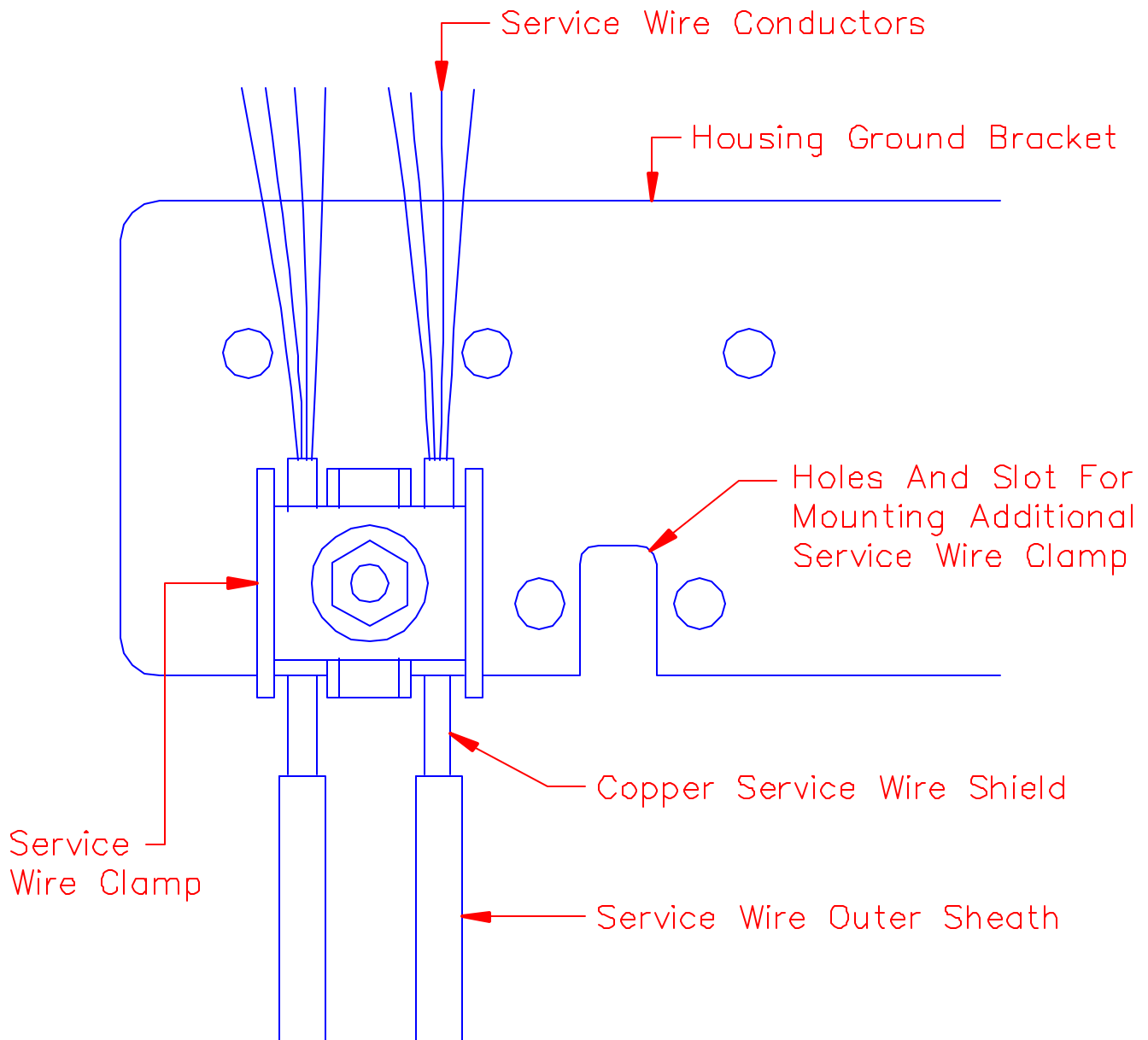

FIGURE 17
GROUNDING SERVICE WIRE SHIELDS USING SERVICE WIRE CLAMP



Note: Provide a loop in service drops to allow for movement of the drops without damage to the grounding connection.

FIGURE 18
ALTERNATIVE METHOD OF GROUNDING BURIED
SERVICE WIRES INSIDE PEDESTALS

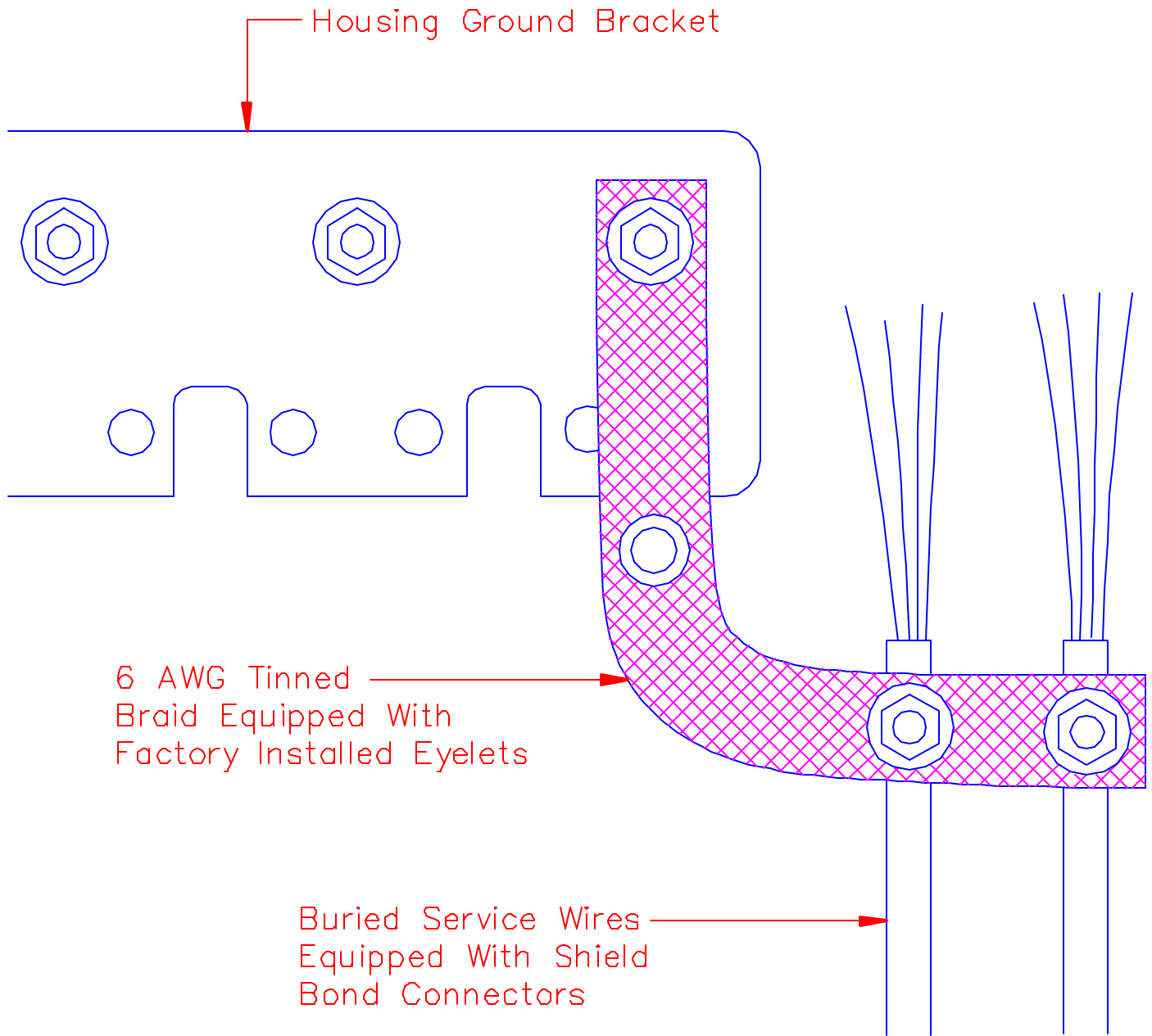

FIGURE 19

BONDING AND GROUNDING BURIED FIBER OPTIC SPLICES

